

# VIVAX

*Made for you*

**HPM-61CH180AERIs R32-3**  
**HPM-75CH220AERIs R32-3**  
**HPM-89CH260AERIs R32-3**  
**HPM-102CH300AERIs R32-3**

**EN**

User manual



**RoHS**



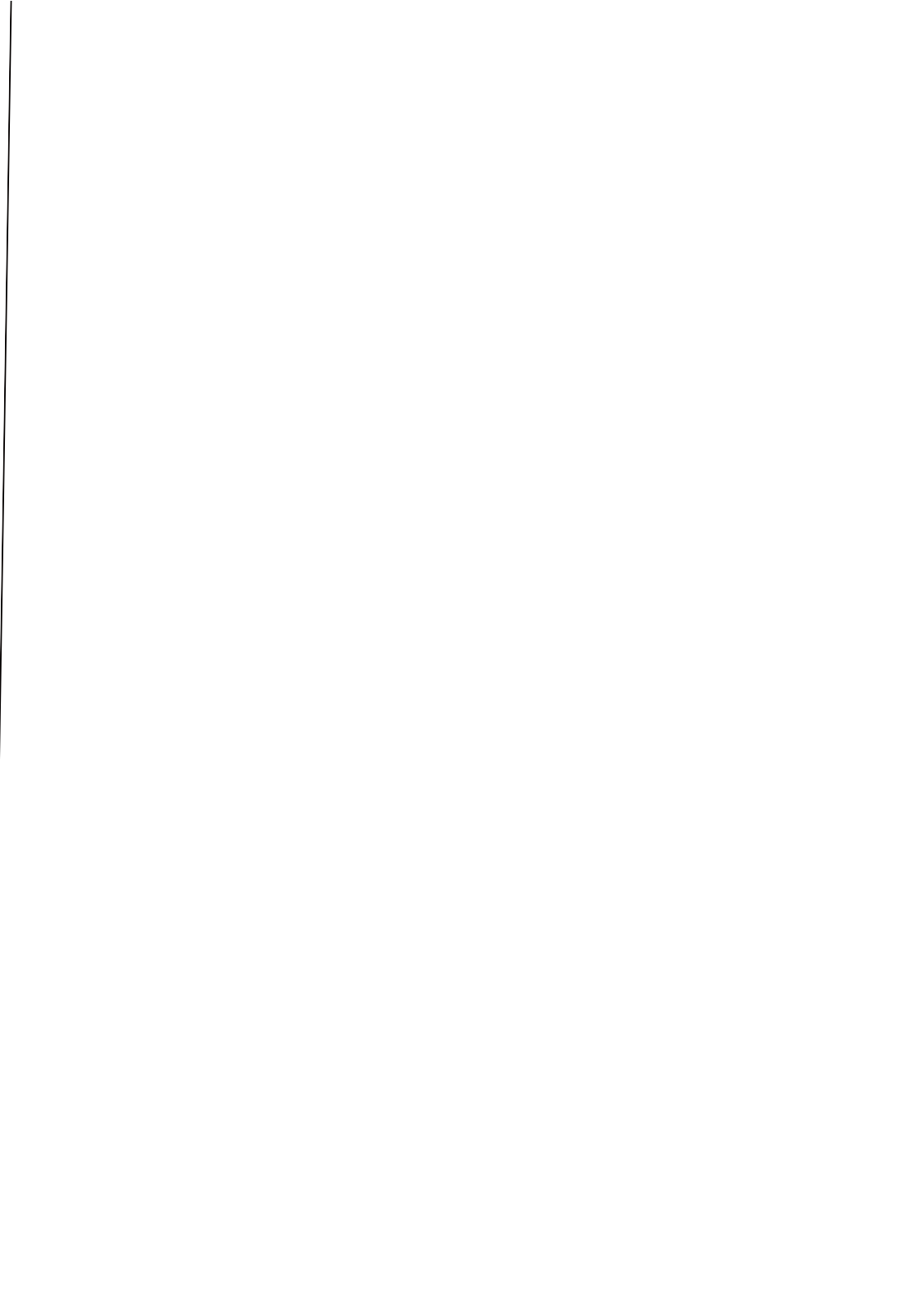

# CONTENTS

<b>1 SAFETY CONSIDERATIONS</b>	02
<b>2 GENERAL INFORMATION</b>	04
<b>3 ACCESSORIES</b>	06
<b>4 BEFORE INSTALLATION</b>	06
<b>5 IMPORTANT INFORMATION FOR THE REFRIGERANT</b>	07
<b>6 INSTALLATION SITE</b>	
• 6.1 Selecting a location in cold climates	08
• 6.2 Selecting a location in hot climates	09
<b>7 INSTALLATION PRECAUTIONS</b>	
• 7.1 Dimensions	09
• 7.2 Installation requirements	09
• 7.3 Drain hole position	10
• 7.4 Servicing space requirements	10
<b>8 TYPICAL APPLICATIONS</b>	
• 8.1 Application 1	11
• 8.2 Application 2	12
• 8.3 Application 3	13
• 8.4 Application 4	14
• 8.5 Application 5	17
• 8.6 Application 6	18
• 8.7 Application 7	20
<b>9 OVERVIEW OF THE UNIT</b>	
• 9.1 Disassembling the unit	21
• 9.2 Main components	21
• 9.3 Electronic control box	22
• 9.4 Water piping	27
• 9.5 Adding water	31
• 9.6 Water piping insulation	32
• 9.7 Field wiring	32
<b>10 START-UP AND CONFIGURATION</b>	
• 10.1 Climate related curves	41
• 10.2 DIP switch settings overview	42

• 10.3 Initial start-up at low outdoor ambient temperature .....	43
• 10.4 Pre-operation checks .....	43
• 10.5 Powering up the unit .....	44
• 10.6 Setting the pump speed .....	44
• 10.7 Field settings .....	46
<b>11 TEST RUN AND FINAL CHECKS</b>	
• 11.1 Final checks .....	57
• 11.2 Test run operation (manually) .....	57
<b>12 MAINTENANCE AND SERVICE</b> .....	57
<b>13 TROUBLE SHOOTING</b>	
• 13.1 General guidelines .....	58
• 13.2 General symptoms .....	58
• 13.3 Operation parameter .....	60
• 13.4 Error codes .....	61
<b>14 TECHNICAL SPECIFICATIONS</b> .....	69
<b>15 INFORMATION SERVICING</b> .....	70

---

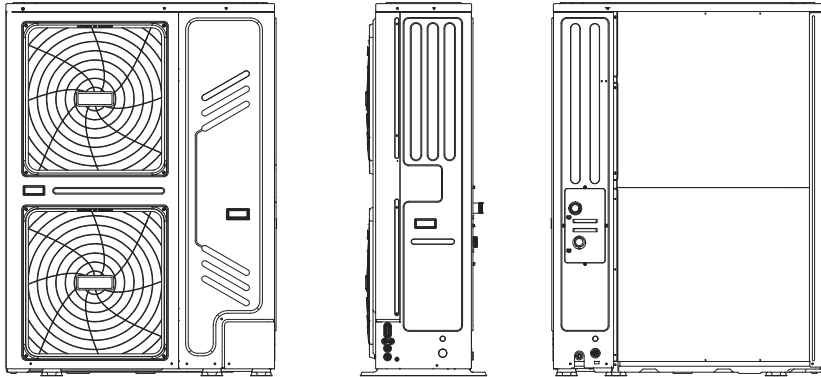

Wiring diagram:

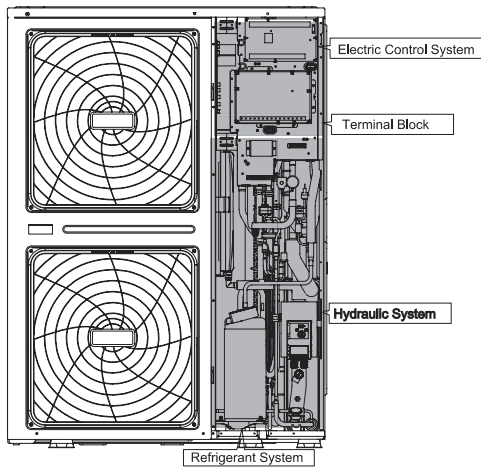

**NOTE**

The picture and function described in this manual contain the backup heater components.

**NOTE**

- Maximum length of communication wirings between the indoor unit and the controller is 50m.
- Power cords and communication wiring must be laid out separately, they can not be placed in the same conduit. Otherwise, it may lead to electromagnetic interference. Power cords and communication wirings should not come in contact with the refrigerant pipe so as to prevent the high temperature pipe from damaging wirings.
- Communication wirings must use shielded lines. Including indoor unit to outdoor unit PQE line ,indoor unit to controller ABXYE line.

# 1 SAFETY PRECAUTIONS

The precautions listed here are divided into the following types. They are quite important, so be sure to follow them carefully. Meanings of DANGER, WARNING, CAUTION and NOTE symbols.

## INFORMATION

- Read these instructions carefully before installation. Keep this manual in a handy for future reference.
- Improper installation of equipment or accessories may result in electric shock, short-circuit, leakage, fire or other damage to the equipment. Be sure to only use accessories made by the supplier, which are specifically designed for the equipment and make sure to get installation done by a professional.
- All the activities described in this manual must be carried out by a licensed technician. Be sure to wear adequate personal protection equipment such as gloves and safety glasses while installation the unit or carrying out maintenance activities.
- Contact your dealer for any further assistance.



Caution: Risk of fire/  
flammable materials

## WARNING

Servicing shall only be performed as recommended by the equipment manufacturer. Maintenance and repair requiring the assistance of other skilled personnel shall be carried out under the supervision of the person competent in the use of flammable refrigerants.

## DANGER

Indicates an imminently hazardous situation which if not avoided, will result in death or serious injury.

## WARNING

Indicates a potentially hazardous situation which if not avoided, could result in death or serious injury.





## CAUTION

Indicates a potentially hazardous situation which if not avoided, may result in minor or moderate injury. It is also used to alert against unsafe practices.

## NOTE

Indicates situations that could only result in accidental equipment or property damage.

### Explanation of symbols displayed on the indoor unit or outdoor unit

	WARNING	This symbol shows that this appliance used a flammable refrigerant. If the refrigerant is leaked and exposed to an external ignition source, there is a risk of fire.
	CAUTION	This symbol shows that the operation manual should be read carefully.
	CAUTION	This symbol shows that a service personnel should be handling this equipment with reference to the installation manual.
	CAUTION	This symbol shows that a service personnel should be handling this equipment with reference to the installation manual.
	CAUTION	This symbol shows that information is available such as the operating manual or installation manual.

## DANGER

- Before touching electric terminal parts, turn off power switch.
- When service panels are removed, live parts can be easily touched by accident.
- Never leave the unit unattended during installation or servicing when the service panel is removed.
- Do not touch water pipes during and immediately after operation as the pipes may be hot and could burn your hands. To avoid injury, give the piping time to return to normal temperature or be sure to wear protective gloves.
- Do not touch any switch with wet fingers. Touching a switch with wet fingers can cause electrical shock.
- Before touching electrical parts, turn off all applicable power to the unit.

## WARNING

- Tear apart and throw away plastic packaging bags so that children will not play with them. Children playing with plastic bags face danger of death by suffocation.
- Safely dispose of packing materials such as nails and other metal or wood parts that could cause injuries.
- Ask your dealer or qualified personnel to perform installation work in accordance with this manual. Do not install the unit yourself. Improper installation could result in water leakage, electric shocks or fire
- Be sure to use only specified accessories and parts for installation work. Failure to use specified parts may result in water leakage, electric shocks, fire, or the unit falling from its mount.
- Install the unit on a foundation that can withstand its weight. Insufficient physical strength may cause the equipment to fall and possible injury.
- Perform specified installation work with full consideration of strong wind, hurricanes, or earthquakes. Improper installation work may result in accidents due to equipment falling.
- Make certain that all electrical work is carried out by qualified personnel according to the local laws and regulations and this manual using a separate circuit. Insufficient capacity of the power supply circuit or improper electrical construction may lead to electric shocks or fire.
- Be sure to install a ground fault circuit interrupter according to local laws and regulations. Failure to install a ground fault circuit interrupter may cause electric shocks and fire.
- Make sure all wiring is secure. Use the specified wires and ensure that terminal connections or wires are protected from water and other adverse external forces. Incomplete connection or affixing may cause a fire.
- When wiring the power supply, form the wires so that the front panel can be securely fastened. If the front panel is not in place there could be overheating of the terminals, electric shocks or fire.
- After completing the installation work, check to make sure that there is no refrigerant leakage.
- Never directly touch any leaking refrigerant as it could cause severe frostbite. Do not touch the refrigerant pipes during and immediately after operation as the refrigerant pipes may be hot or cold, depending on the condition of the refrigerant flowing through the refrigerant piping, compressor and other refrigerant cycle parts. Burns or frostbite are possible if you touch the refrigerant pipes. To avoid injury, give the pipes time to return to normal temperature or, if you must touch them be sure to wear protective gloves.
- Do not touch the internal parts (pump, backup heater, etc.) during and immediately after operation. Touching the internal parts can cause burns. To avoid injury, give the internal parts time to return to normal temperature or, if you must touch them, be sure to wear protective gloves.

## CAUTION

- Ground the unit.
- Grounding resistance should be according to local laws and regulations.
- Do not connect the ground wire to gas or water pipes, lightning conductors or telephone ground wires.
- Incomplete grounding may cause electric shocks.
  - Gas pipes: Fire or an explosion might occur if the gas leaks.
  - Water pipes: Hard vinyl tubes are not effective grounds.
  - Lightning conductors or telephone ground wires: Electrical threshold may rise abnormally if struck by a lightning bolt.
- Install the power wire at least 3 feet (1 meter) away from televisions or radios to prevent interference or noise. (Depending on the radio waves, a distance of 3 feet (1 meter) may not be sufficient to eliminate the noise.)
- Do not wash the unit. This may cause electric shocks or fire. The appliance must be installed in accordance with national wiring regulations. If the supply cord is damaged, it must be replaced by the manufacturer, its service agent or similarly qualified persons in order to avoid a hazard.

- Do not install the unit in the following places:
  - Where there is mist of mineral oil, oil spray or vapors. Plastic parts may deteriorate, and cause them to come loose or water to leak.
  - Where corrosive gases (such as sulphurous acid gas) are produced. Where corrosion of copper pipes or soldered parts may cause refrigerant to leak.
  - Where there is machinery which emits electromagnetic waves. Electromagnetic waves can disturb the control system and cause equipment malfunction.
  - Where flammable gases may leak, where carbon fiber or ignitable dust is suspended in the air or where volatile flammables such as paint thinner or gasoline are handled. These types of gases might cause a fire.
  - Where the air contains high levels of salt such as near the ocean.
  - Where voltage fluctuates a lot, such as in factories.
  - In vehicles or vessels.
  - Where acidic or alkaline vapors are present.
- This appliance can be used by children 8 years old and above and persons with reduced physical, sensory or mental capabilities or lack of experience and knowledge if they are supervised or given instruction on using the unit in a safe manner and understand the hazards involved, Children should not play with the unit. Cleaning and user maintenance should not be done by children without supervision.
- Children should be supervised to ensure that they do not play with the appliance.  
If the supply cord is damaged, it must be replaced by the manufacturer or its service agent or a similarly qualified person.
- **DISPOSAL:** Do not dispose this product as unsorted municipal waste. Collection of such waste separately for special treatment is necessary. Do not dispose of electrical appliances as municipal waste, use separate collection facilities. Contact your local government for information regarding the collection systems available. If electrical appliances are disposed of in landfills or dumps, hazardous substance can leak into the groundwater and get into the food chain, damaging your health and well-being.
- The wiring must be performed by professional technicians in accordance with national wiring regulation and this circuit diagram. An all-pole disconnection device which has at least 3mm separation distance in all pole and a residual current device(RCD) with the rating not exceeding 30mA shall be incorporated in the fixed wiring according to the national rule.
- Confirm the safety of the installation area ( walls, floors, etc. ) without hidden dangers such as water, electricity, and gas. Before wiring/pipes.
- Before installation , check whether the user's power supply meets the electrical installation requirements of unit ( including reliable grounding , leakage , and wire diameter electrical load, etc. ). If the electrical installation requirements of the product are not met, the installation of the product is prohibited until the product is rectified.
- When installing multiple air conditioners in a centralized manner, please confirm the load balance of the three-phase power supply, and multiple units are prevented from being assembled into the same phase of the three-phase power supply.
- Product installation should be fixed firmly, Take reinforcement measures, when necessary.
- In order to ensure the safety of the product, please restart the unit at least once every 3 months, so that the unit can carry out self-inspection operation.

#### **NOTE**

- About Fluorinated Gasses
  - This air-conditioning unit contains fluorinated gasses. For specific information on the type of gas and the amount, please refer to the relevant label on the unit itself. Compliance with national gas regulations shall be observed.
  - Installation, service, maintenance and repair of this unit must be performed by a certified technician.
  - Product uninstallation and recycling must be performed by a certified technician.
  - If the system has a leak-detection system installed, it must be checked for leaks at least every 12 months. When the unit is checked for leaks, proper record-keeping of all checks is strongly recommended.

## 2 GENERAL INTRODUCTION

- These units are used for both heating and cooling applications. They can be combined with fan coil units, floor heating applications, low temperature high efficiency radiators, domestic hot water tanks (field supply) and solar kits (field supply).
- A wired controller is supplied with the unit .
- Room thermostat (field supply) can be connected to the unit(room thermostat should be kept away from heating source when selecting the installation place).



- Solar kit for domestic hot water tank(field supply)  
An optional solar kit can be connected to the unit.
- Remote alarm kit (field supply) can be connected to the unit.
- Operation range

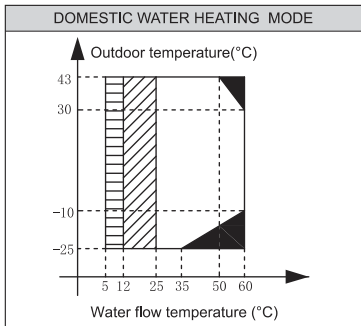
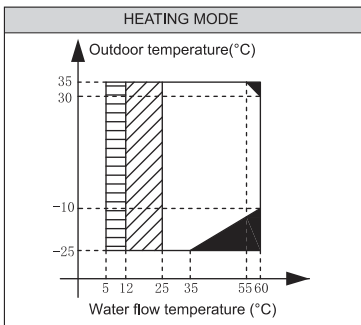
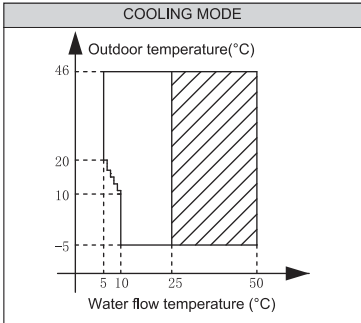

- ▨ If IBH/AHS setting is valid, only IBH/AHS turns on; If IBH/AHS setting is invalid, only heat pump turns on;
- No heat pump operation, IBH or AHS only
- ▨ Water flow temperature drop or rise interval

- If you add the backup heater in the system, the backup heater can increase the heating capacity during cold outdoor temperatures. The backup heater also serves as a backup in case of malfunctioning and for freeze protection of the outside water piping during winter time. The capacity of backup heater for different units is listed below.

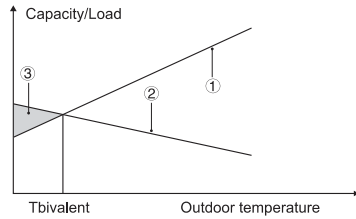

- ① Heat pump capacity.
- ② Required heating capacity (site dependent).
- ③ Additional heating capacity provided by backup heater.

- The unit have a freeze prevention function that uses the heat pump to keep the water system safe from freezing in all conditions. Since a power failure may happen when the unit is unattended, It's suggested to use anti-freezing flow switch in the water system. (Refer to 9.4 Water piping).
- In cooling mode, the minimum leaving water flow temperature(T1stop) that the unit can reach in different outdoor temperature(T4) is listed below:

Outdoor temp. (°C)	≤10	11	12	13
Water flow temp. (°C)	10	9	9	8
Outdoor temp. (°C)	14	15	16	17
Water flow temp. (°C)	8	7	7	6
Outdoor temp. (°C)	18	19	20	≥21
Water flow temp. (°C)	6	6	5	5

















- In heating mode, the maximum leaving water flow temperature (T1stop) that heat pump can reach in different outdoor temperature (T4) is listed below:

Outdoor temp. (°C)	-25	-24	-23	-22	
Water flow temp. (°C)	35	35	35	37	39
Outdoor temp. (°C)	-20	-19	-18	-17	
Water flow temp. (°C)	40	42	44	46	48
Outdoor temp. (°C)	-15	-14	-13	-12	
Water flow temp. (°C)	50	52	54	56	58
Outdoor temp. (°C)	-10~30		31	32	
Water flow temp. (°C)		60	59	58	57
Outdoor temp. (°C)	34	35			
Water flow temp. (°C)	56	55			

- In DHW mode, the maximum domestic hot water temperature(T5stop) that heat pump can reach in different outdoor temperature(T4) is listed below:

Outdoor temp. (°C)	-25~-21	-20~-14	-15~-11	-10~-4	-5~-1
DHW Water flow temp. (°C)	35	40	45	48	50
Outdoor temp. (°C)	0~4	5~9	10~14	15~19	20~24
DHW Water flow temp. (°C)	53	55	55	53	50
Outdoor temp. (°C)	25~29	30~34	35~39	40~43	
DHW Water flow temp. (°C)	50	48	48	45	

### 3 ACCESSORIES

Accessories supplied with the unit					
Name	Shape	Quantity	Name	Shape	Quantity
Installation and owner's manual(this book)		1	Y-shape filter		1
Operation manual		1	Water outlet connection pipe assembly		2
Technical data manual		1	Wired controller		1
Thermistor for domestic hot water tank (T5) *		1	Adapter for inlet water pipe		1
Extension wire for T5		1	Network matching wire***		1
Tighten belt for customer wiring use		2			
Accessories available from supplier					
Thermistor for balance tank (Tbt1)*		1	Extension wire for Tbt1		1
Thermistor for Zone 2 flow temp. (Tw2)		1	Extension wire for Tw2		1
Thermistor for solar temp. (Tsolar)		1	Extension wire for Tsolar		1

\*If the system is installed in parallel, Tbt1 must be connected and installed in the balance tank.

\*\*When the units are connected in parallel, such as when the communication between the unit is unstable (such as an Hd fault code), add a network matching wire between the ports H1 and H2 at the terminal of the communication system;

Sensors Tbt1, T5 and extension wire can be shared, sensors Tw2, Tsolar and extension wire can be shared, if these functions are needed at the same time, please customize these sensors and extension additionally.

### 4 BEFORE INSTALLATION

- **Before installation:** Be sure to confirm the model name and the serial number of the unit.
- **Handling:** Due to relatively large dimensions and heavy weight, the unit should only be handled using lifting tools with slings. The slings can be fitted into foreseen sleeves at the base frame that are made specifically for this purpose.

#### CAUTION

- To avoid injury, do not touch the air inlet or aluminum fins of the unit.
- Do not use the grips in the fan grills to avoid damage.
- The unit is top heavy! Prevent the unit from falling due to improper inclination during handling.

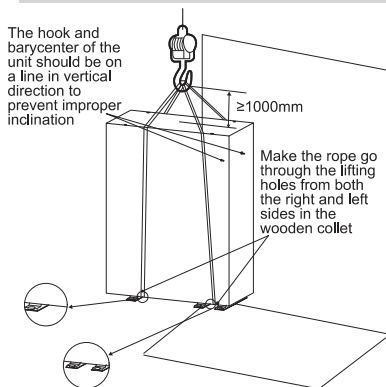

The position of barycenter for different unit can be seen in the picture below. (unit:mm)

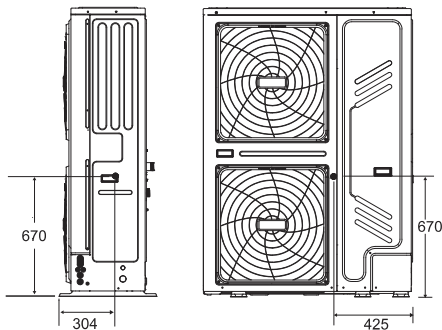

## 5 IMPORTANT INFORMATION FOR THE REFRIGERANT

This product has the fluorinated gas, it is forbidden to release to air.

Refrigerant type: R32; Volume of GWP: 675.

GWP=Global Warming Potential

Model	Factory charged refrigerant volume in the unit	
	Refrigerant/kg	Tonnes CO <sub>2</sub> equivalent
18kW	5,00	3.38
22kW	5,00	3.38
26kW	5,00	3.38
30kW	5,00	3.38

### CAUTION

- Frequency of Refrigerant Leakage Checks
  - For unit that contains fluorinated greenhouse gases in quantities of 5 tonnes of CO<sub>2</sub> equivalent or more, but of less than 50 tonnes of CO<sub>2</sub> equivalent, at least every 12 months, or where a leakage detection system is installed, at least every 24 months.
  - For unit that contains fluorinated greenhouse gases in quantities of 50 tonnes of CO<sub>2</sub> equivalent or more, but of less than 500 tonnes of CO<sub>2</sub> equivalent at least every six months, or where a leakage detection system is installed, at least every 12 months.
  - For unit that contains fluorinated greenhouse gases in quantities of 500 tonnes of CO<sub>2</sub> equivalent or more, at least every three months, or where a leakage detection system is installed, at least every six months.
  - This air-conditioning unit is a hermetically sealed equipment that contains fluorinated greenhouse gases.
  - Only certificated person is allowed to do installation, operation and maintenance.

## 6 INSTALLATION SITE

### WARNING

- There is flammable refrigerant in the unit and it should be installed in a well-ventilated site. If the unit is installed inside, an additional refrigerant detection device and ventilation equipment must be added in accordance with the standard EN378. Be sure to adopt adequate measures to prevent the unit from being used as a shelter by small animals.
- Small animals making contact with electrical parts can cause malfunction, smoke or fire. Please instruct the customer to keep the area around the unit clean.
- Select an installation site where the following conditions are satisfied and one that meets with your customer's approval.
  - Places that are well-ventilated.
  - Places where the unit does not disturb next-door neighbors.
  - Safe places which can bear the unit's weight and vibration and where the unit can be installed at an even level.
  - Places where there is no possibility of flammable gas or product leak.
  - The equipment is not intended for use in a potentially explosive atmosphere.
  - Places where servicing space can be well ensured.
  - Places where the units' piping and wiring lengths come within the allowable ranges.
  - Places where water leaking from the unit cannot cause damage to the location (e.g. in case of a blocked drain pipe).
  - Places where rain can be avoided as much as possible.
  - Do not install the unit in places often used as a work space. In case of construction work (e.g. grinding etc.) where a lot of dust is created, the unit must be covered.
  - Do not place any object or equipment on top of the unit (top plate)
  - Do not climb, sit or stand on top of the unit.
  - Be sure that sufficient precautions are taken in case of refrigerant leakage according to relevant local laws and regulations.
  - Don't install the unit near the sea or where there is corrosion gas.
- When installing the unit in a place exposed to strong wind, pay special attention to the following.

- Strong winds of 5 m/sec or more blowing against the unit's air outlet causes a short circuit (suction of discharge air), and this may have the following consequences:
  - Deterioration of the operational capacity.
  - Frequent frost acceleration in heating operation.
  - Disruption of operation due to rise of high pressure.
  - When a strong wind blows continuously on the front of the unit, the fan can start rotating very fast until it breaks.

In normal condition, refer to the figures below for installation of the unit:

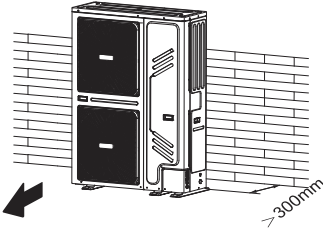

In case of strong wind and the wind direction can be foreseen, refer to the figures below for installation of the unit (any one is OK):

Turn the air outlet side toward the building's wall, fence or screen.

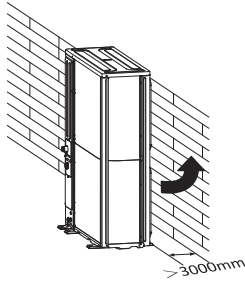

Make sure there is enough room to do the installation.

Set the outlet side at a right angle to the direction of the wind.

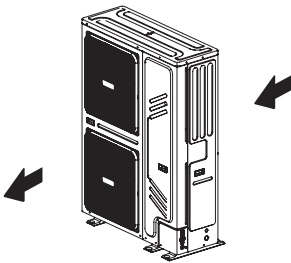

- Prepare a water drainage channel around the foundation, to drain waste water from around the unit.
- If water does not easily drain from the unit, mount the unit on a foundation of concrete blocks, etc. (the height of the foundation should be about 100 mm (3.93 in).

- If you install the unit on a frame, please install a waterproof plate (about 100 mm) on the underside of the unit to prevent water from coming in from the low side.
- When installing the unit in a place frequently exposed to snow, pay special attention to elevate the foundation as high as possible.
- If you install the unit on a building frame, please install a waterproof plate (field supply) (within 150mm of the underside of the unit) in order to avoid drain water dripping. (See the picture in the right).



## 6.1 Selecting a location in cold climates

Refer to "Handling" in section "4 Before installation"

### NOTE

When operating the unit in cold climates, be sure to follow the instructions described below.

- To prevent exposure to wind, install the unit with its suction side facing the wall.
- Never install the unit at a site where the suction side may be exposed directly to wind.
- To prevent exposure to wind, install a baffle plate on the air discharge side of the unit.
- In heavy snowfall areas, it is very important to select an installation site where the snow will not affect the unit. If lateral snowfall is possible, make sure that the heat exchanger coil is not affected by the snow (if necessary construct a lateral canopy).

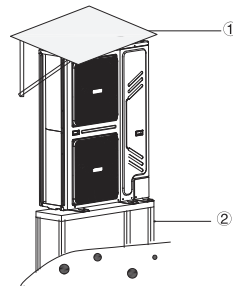

- ① Construct a large canopy.
- ② Construct a pedestal. Install the unit high enough off the ground to prevent it from being buried in snow.

## 6.2 Selecting a location in hot climates

As the outdoor temperature is measured via the outdoor unit air thermistor, make sure to install the outdoor unit in the shade or a canopy should be constructed to avoid direct sunlight, so that it is not influenced by the sun's heat, otherwise protection may be possible to the unit.

## 7 INSTALLATION PRECAUTIONS

### 7.1 Dimensions

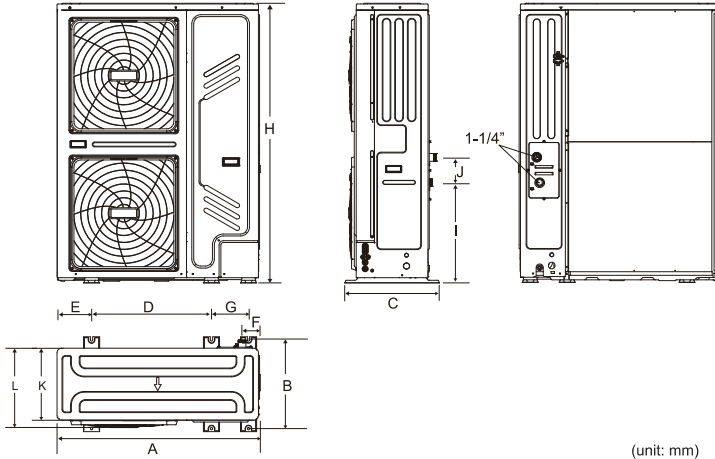

Model	A	B	C	D	E	F	G	H	I	J	K	L
18/22/26/30 kW	1129	494	528	668	192	98	206	1558	558	143	400	440

### 7.2 Installation requirements

- Check the strength and level of the installation ground so that the unit may not cause any vibrations or noise during its operation.
- In accordance with the foundation drawing in the figure, fix the unit securely by means of foundation bolts. (Prepare six sets each of  $\Phi 10$  Expansion bolts, nuts and washers which are readily available in the market.)
- Screw in the foundation bolts until their length is 20 mm from the foundation surface.

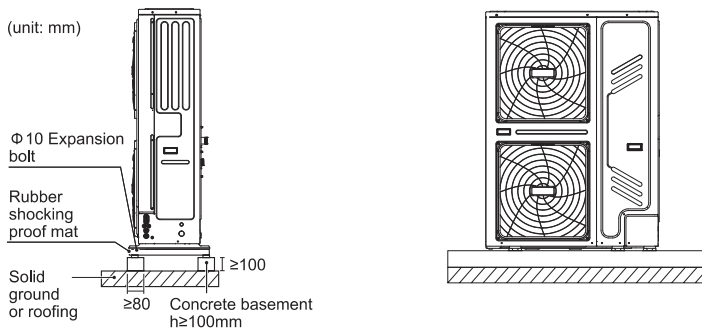

### 7.3 Drain hole position

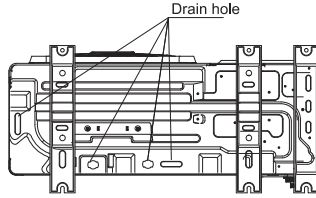

**NOTE**

It's necessary to install an electrical heating belt if water can't drain out in cold weather.

### 7.4 Servicing space requirements

- 1) Single unit installation

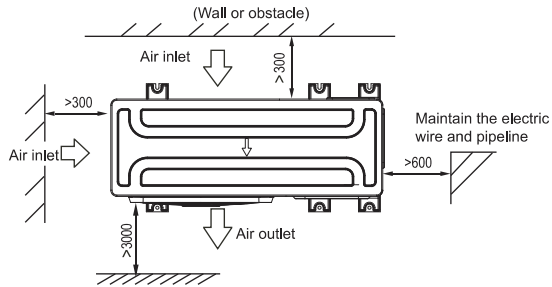

- 2) Parallel connect the two units or above

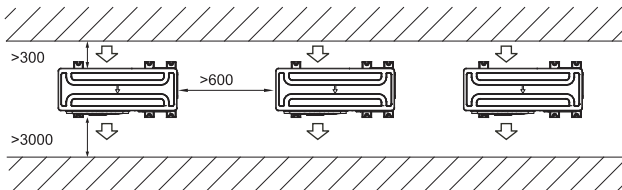

- 3) Parallel connect the front with rear sides

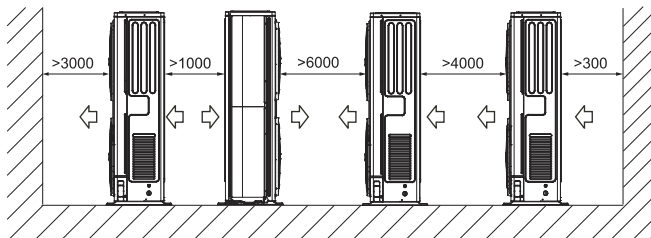

## 8 TYPICAL APPLICATIONS

The application examples given below are for illustration only.

### 8.1 Application 1

Space heating with a room thermostat connected to the unit.

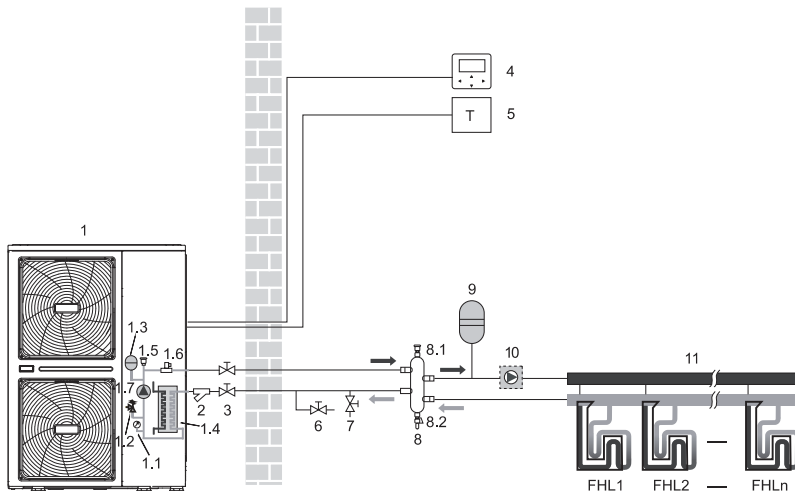

Coding	Assembly unit	Coding	Assembly unit
1	Outdoor unit	5	Room thermostat (field supply)
1.1	Manometer	6	Drain valve (field supply)
1.2	Pressure relief valve	7	Fill valve (field supply)
1.3	Expansion vessel	8	Balance tank (field supply)
1.4	Plate heat exchanger	8.1	Air purge valve
1.5	Air purge valve	8.2	Drain valve
1.6	Flow switch	9	Expansion vessel (field supply)
1.7	P <sub>i</sub> : Circulation pump inside the unit	10	P <sub>o</sub> : Outside circulation pump (field supply)
2	Y-shape filter	11	Collector / distributor (field supply)
3	Stop valve (field supply)	FHL 1...n	Floor heating loop (field supply)
4	Wired controller		

#### NOTE

The volume of balance tank(8) should be greater than 40L. The drain valve (6) should be installed at the lowest position of the system. Pump<sub>o</sub> (10) should be controlled by outdoor unit and connect to corresponding port in the outdoor unit(**refer to 9.7.6 Connection for other components/For outside circulation pump P<sub>o</sub>**).

Unit operation and space heating:

When a room thermostat is connected to the unit and when there is a heating request from the room thermostat, the unit will start operating to achieve the target water flow temperature as set on the user interface. When the room temperature is above the thermostat set point in the heating mode, the unit will stop operating. The circulation pump (1.7) and (10) will also stop running. The room thermostat is used as a switch here.

**NOTE**

Make sure to connect the thermostat wires to the correct terminals, method B should be selected (see "For room thermostat" in **9.7.6 connection for other components**). To correctly configure the ROOM THERMOSTAT in the FOR SERVICEMAN mode see **10.7 Field settings/ROOM THERMOSTAT**.

### 8.2 Application 2

Space heating without room thermostat connected to the unit. Domestic hot water tank is connected to the unit, and the tank is with solar heating system.

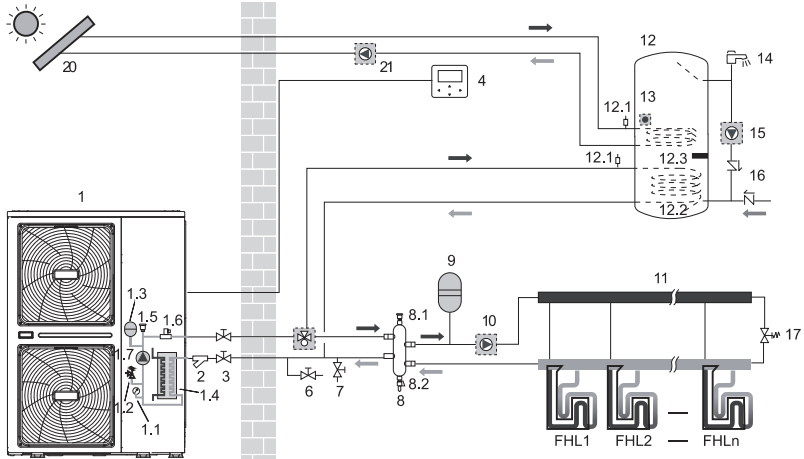

Coding	Assembly unit	Coding	Assembly unit
1	Outdoor unit	9	Expansion vessel (field supply)
1.1	Manometer	10	P_o: Outside circulation pump (field supply)
1.2	Pressure relief valve	11	Collector / distributor (field supply)
1.3	Expansion vessel	12	Domestic hot water tank (field supply)
1.4	Plate heat exchanger	12.1	Air purge valve
1.5	Air purge valve	12.2	Heat exchanger coil
1.6	Flow switch	12.3	Booster heater
1.7	P_i: Circulate pump in the unit	13	T5: DHW tank temp. sensor
2	Y-shape filter	14	Hot water tap (field supply)
3	Stop valve (field supply)	15	P_d: DHW pump (field supply)
4	Wired controller	16	One way valve (field supply)
6	Drain valve (field supply)	17	Bypass valve(field supply)
7	Fill valve (field supply)	18	SV1: 3-way valve (field supply)
8	Balance tank (field supply)	20	Solar energy kit(field supply)
8.1	Air purge valve	21	P_s: Solar pump(field supply)
8.2	Drain valve	FHL 1...n	Floor heating loop (field supply)

**NOTE**

The volume of balance tank(8) should be greater than 40L. The drain valve (6) should be installed at the lowest position in the system. Pump(10) should be controlled by outdoor unit and connect to corresponding port in the outdoor unit(refer to **9.7.6 Connection for other components/For outside circulation pump P\_o**).



- **Circulation pump operation**

The circulation pump (1.7) and (10) will operate as long as the unit is on for space heating. The circulation pump (1.7) will operate as long as the unit is on for heating domestic hot water (DHW).

- **Space heating**

- 1) The unit (1) will operate to achieve the target water flow temperature set on the wired controller.
- 2) The bypass valve should be selected so that at all times the minimum water flow as mentioned in **9.4 Water piping** is guaranteed.

- **Domestic water heating**

- 1) When the domestic water heating mode is enabled (either manually by the user, or automatically through scheduling) the target domestic hot water temperature will be achieved by a combination of the heat exchanger coil and the electrical booster heater (when the booster heater in the tank is set to YES).
- 2) When the domestic hot water temperature is below the user configured set point, the 3-way valve will be activated to heat the domestic water by means of the heat pump. If there is a huge demand for hot water or a high hot water temperature setting, the booster heater (12.3) can provide auxiliary heating.

**CAUTION**

Make sure to fit the 3-way valve correctly. For more details, refer to **9.7.6 Connection for other components/For 3-way valve SV1**.

**NOTE**

The unit can be configured so that at low outdoor temperatures, water is exclusively heated by the booster heater. This assures that the full capacity of the heat pump is available for space heating.

Details on domestic hot water tank configuration for low outdoor temperatures (T4DHWMIN) can be found in **10.7 Field settings/How to set the DHW MODE**.

### 8.3 Application 3

Space cooling and heating application with a room thermostat suitable for heating/cooling changeover when connected to the unit. Heating is provided through floor heating loops and fan coil units. Cooling is provided through the fan coil units only. Domestic hot water is provided through the domestic hot water tank which is connected to the unit.

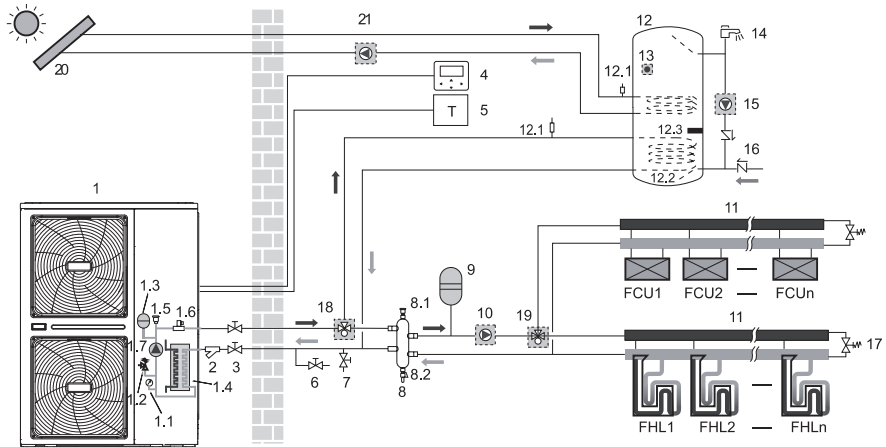

Coding	Assembly unit	Coding	Assembly unit
1	Outdoor unit	10	P_o: Outside circulation pump (field supply)
1.1	Manometer	11	Collector / distributor (field supply)
1.2	Pressure relief valve	12	Domestic hot water tank (field supply)
1.3	Expansion vessel	12.1	Air purge valve
1.4	Plate heat exchanger	12.2	Heat exchanger coil
1.5	Air purge valve	12.3	Booster heater
1.6	Flow switch	13	T5: DHW tank temp. sensor
1.7	P_i: Circulation pump inside the unit	14	Hot water tap (field supply)
2	Y-shape filter	15	P_d: DHW pump (field supply)
3	Stop valve (field supply)	16	One way valve (field supply)
4	Wired controller	17	Bypass valve(field supply)
5	Room thermostat (field supply)	18	SV1: 3-way valve (field supply)
6	Drain valve (field supply)	19	SV2: 3-way valve (field supply)
7	Fill valve (field supply)	20	Solar energy kit(field supply)
8	Balance tank (field supply)	21	P_s: Solar pump(field supply)
8.1	Air purge valve	FHL 1...n	Floor heating loop (field supply)
8.2	Drain valve	FCU 1...n	Fan coil units (field supply)
9	Expansion vessel (field supply)		

#### NOTE

The volume of balance tank(8) should be greater than 40L.The drain valve (6) should be installed at the lowest position of the system. Pump(10) should be controlled by outdoor unit and connect to corresponding port in the outdoor unit(refer to **9.7.6 Connection for other components/For outside circulation pump P\_o**).

#### • Pump operation and space heating and cooling

The unit will switch to either heating or cooling mode according to the setting of room thermostat. When space heating/cooling is requested by the room thermostat (5), the pump will start operating and the unit (1) will switch to heating mode/cooling mode. The unit (1) will operate to achieve the target cold/hot water leaving temperature. In the cooling mode, the motorized 3-way valve (19) will close to prevent cold water running through the floor heating loops (FHL).

#### CAUTION

Make sure to connect the thermostat wires to the correct terminals and to configure the ROOM THERMOSTAT in the wired controller correctly (see **10.7 Field settings/ROOM THERMOSTAT**). Wiring of the room thermostat should follow method A as described in **9.7.6 connection for other components/For room thermostat**.

Wiring of the 3-way valve (19) is different for a NC (normal closed) valve and a NO (normal open) valve! Make sure to connect to the correct terminal numbers as detailed on the wiring diagram.

The ON/OFF setting of the heating/cooling operation cannot be done on the user interface, the target outlet water temperature should be set in the user interface.

#### • Domestic water heating

Domestic water heating is as described in 8.2 Application 2.

## 8.4 Application 4

Space heating with an auxiliary boiler (alternating operation).

Space heating application by either the unit or by an auxiliary boiler connected in the system.

- The unit controlled contact (also called "permission signal for the auxiliary boiler") is determined by the outdoor temperature (thermistor located at the outdoor unit). See **10.7 Field settings/OTHER HEATING SOURCE**.
- Bivalent operation is possible for both space heating operation and domestic water heating operation.
- If the auxiliary boiler only provides heat for space heating, the boiler must be integrated in the piping work and in the field wiring according to the illustration for application a.
- If the auxiliary boiler is also providing heat for domestic hot water, the boiler can be integrated in the piping work and in the field wiring according to the illustration for application b. In this condition, the unit can sent ON/OFF signal to boiler in heating mode, but the boiler control itself in DHW mode.

## ⚠ CAUTION

Be sure that the boiler and the integration of the boiler in the system is in accordance with relevant local laws and regulations.

### 8.4.1 Application a

Boiler provide heat for space heating only

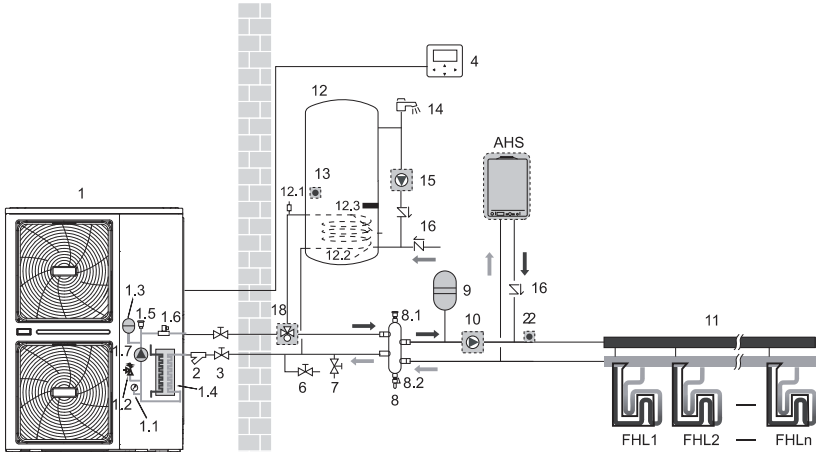

### 8.4.2 Application b

Boiler provide heat for space heating and domestic water heating, the ON/OFF of boiler is controlled by itself for domestic water heating.

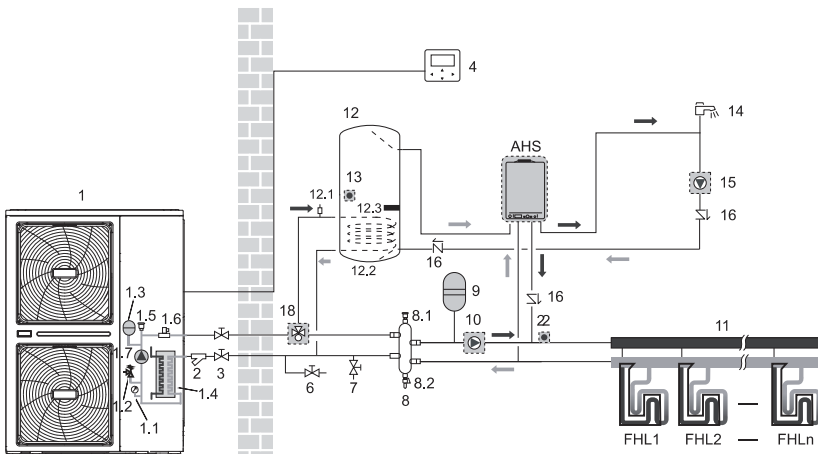

### 8.4.3 Application c

Boiler provide heat for domestic water heating. The ON/OFF of boiler controlled by unit.

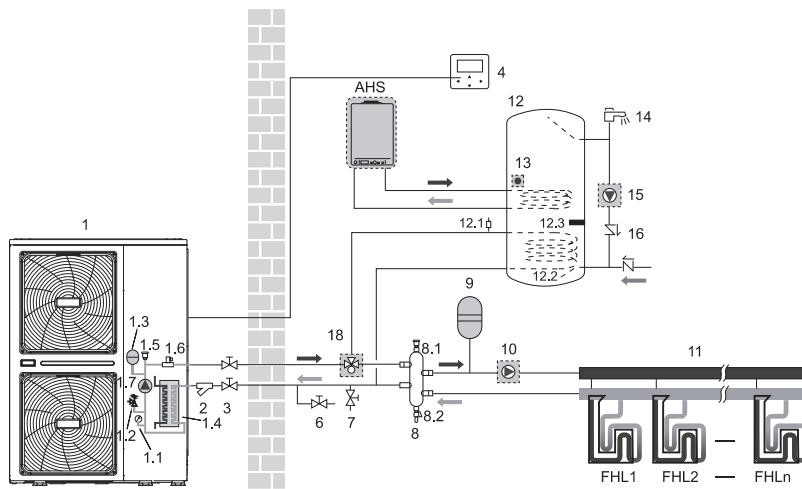

Coding	Assembly unit	Coding	Assembly unit
1	Outdoor unit	9	Expansion vessel (field supply)
1.1	Manometer	10	P_o: Outside circulation pump (field supply)
1.2	Pressure relief valve	11	Collector / distributor (field supply)
1.3	Expansion vessel	12	Domestic hot water tank (field supply)
1.4	Plate heat exchanger	12.1	Air purge valve
1.5	Air purge valve	12.2	Heat exchanger coil
1.6	Flow switch	12.3	Booster heater
1.7	P_i: Circulation pump inside the unit	13	T5: DHW tank temp. sensor
2	Y-shape filter	14	Hot water tap (field supply)
3	Stop valve (field supply)	15	P_d: DHW pump (field supply)
4	Wired controller	16	One way valve (field supply)
6	Drain valve (field supply)	18	SV1: 3-way valve (field supply)
7	Fill valve (field supply)	22	T1: Outlet water temperature sensor(field supply)
8	Balance tank (field supply)	FHL 1...n	Floor heating loop(field supply)
8.1	Air purge valve	AHS	Additional heating source(boiler)(field supply)
8.2	Drain valve	/	/

#### NOTE

The volume of balance tank(8) should be greater than 40L. The drain valve (6) should be installed at the lowest position of the system. Temperature sensor T1 must be installed at the outlet of AHS, and connect to the corresponding port in the main control board of hydraulic module(refer to **9.3.1 Main control board of hydraulic module**), pump(10) should be controlled by outdoor unit and connect to corresponding port in the outdoor unit(refer to **9.7.6 Connection for other components/For outside circulation pump P\_o**).

#### Operation

When heating is required, either the unit or the boiler starts operating, depending on the outdoor temperature (refer to **10.7 field setting/OTHER HEATING SOURCE**).

- As the outdoor temperature is measured via the outdoor unit air thermistor, make sure to install the outdoor unit in the shade, so that it is not influenced by the sun's heat,
- Frequent switching can cause corrosion of the boiler at an early stage. Contact the boiler manufacturer.

- During heating operation of the unit, the unit will operate to achieve the target water flow temperature set on the user interface. When weather dependent operation is active, the water temperature is determined automatically depending on the outdoor temperature.
- During heating operation of the boiler, the boiler will operate to achieve the target water flow temperature set on the user interface.
- Never set the target water flow temperature set point on the user interface above (60°C).

### NOTE

Make sure to correctly configure FOR SERVICEMAN in the user interface. Refer to **10.7 Field settings/Other heating source**.

### CAUTION

Ensure that return water to the heat exchanger does not exceed 60°C. Never put the target water flow temperature set point on the user interface above 60°C.

Make sure that the non-return valves (field supply) are correctly installed in the system.

The supplier will not be held liable for any damage resulting from failure to observe this rule.

## 8.5 Application 5

Dual setpoint function application with two room thermostat connect to the outdoor unit.

- Space heating with two room thermostat application through floor heating loops and fan coil units. The floor heating loops and fan coil units require different operating water temperatures.
- The floor heating loops require a lower water temperature in heating mode compared to fan coil units. To achieve these two set points, a mixing station is used to adapt the water temperature according to requirements of the floor heating loops. The fan coil units are directly connected to the unit water circuit and the floor heating loops are after the mixing station. The mixing station is controlled by the unit (or field supply, controls itself).
- The operation and configuration of the field water circuit is the responsibility of the installer.
- We only offer a dual set point control function. This function allows two set points to be generated. Depending on the required water temperature (floor heating loops and/or fan coil units are required) . More details refer to **10.7 field setting /ROOM THERMOSTAT**.

### NOTE

The wiring of room thermostat 5A(for fan coil units) and 5B(for floor eating loops) should follow 'method C' as described in **9.7.6 Connection for other components/For room thermostat**, and the thermostat which connect to port 'C' (in the outdoor unit) should be placed on the zone where floor heating loops is installed(zone B), the other one connect to port 'H' should be placed on the zone where fan coil units are installed(zone A).

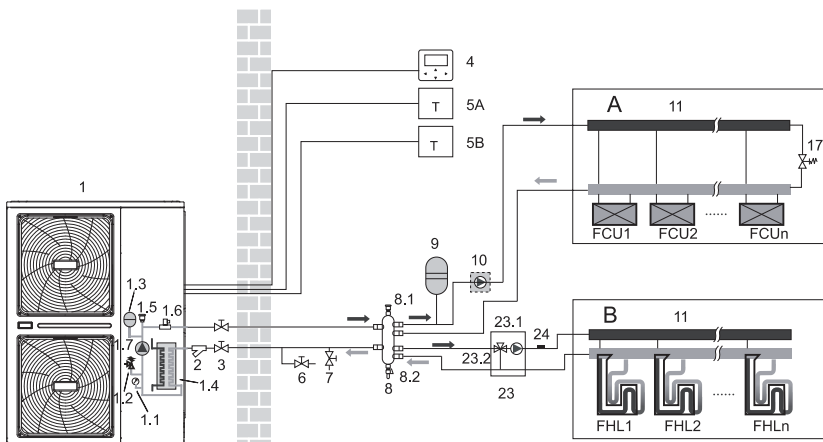

Coding	Assembly unit	Coding	Assembly unit
1	Outdoor unit	7	Fill valve (field supply)
1.1	Manometer	8	Balance tank (field supply)
1.2	Pressure relief valve	8.1	Air purge valve
1.3	Expansion vessel	8.2	Drain valve
1.4	Plate heat exchanger	9	Expansion vessel (field supply)
1.5	Air purge valve	10	P_o: Outside circulation pump (field supply)
1.6	Flow switch	11	Collector / distributor (field supply)
1.7	P_i: Circulation pump in the unit	17	Bypass valve (field supply)
2	Y-shape filter	23	Mixing station (field supply)
3	Stop valve (field supply)	23.1	P_c: zone 2 pump (field supply)
4	Wired controller	23.2	SV3: 3-way valve (field supply)
5A	Room thermostat for zone 1 (field supply)	24	Tw2: Zone 2 water flow temp. (individual purchase)
5B	Room thermostat for zone 2 (field supply)	FHL 1...n	Floor heating loop (field supply)
6	Drain valve (field supply)	FCU 1...n	Fan coil units (field supply)

#### NOTE

- The volume of balance tank(8) should be greater than 40L. The drain valve (6) should be installed at the lowest position of the system. Pump(10) and pump(23.1) should be controlled by outdoor unit and connect to corresponding port in the outdoor unit(refer to **9.7.6 Connection for other components/For outside circulation pump P\_o and For tank loop pump P\_d and mix pump P\_c**).
- The advantage of the dual set point control is that the heat pump will/can operate at the lowest required water flow temperature when only floor heating is required. Higher water flow temperatures are only required in case fan coil units are operating. This results in better heat pump performance.

#### • Pump operation and space heating

The pump (1.7) and (10) will operate when there is request for heating from A and / or B. Pump (23.1) will operate only when there is request for heating from B. The outdoor unit will start operating to achieve the target water flow temperature. The target water leaving temperature depends on which room thermostat is requesting heating.

When the room temperature of both zones is above the thermostat set point, the outdoor unit and pump will stop operating.

#### NOTE

- Make sure to correctly configure the room thermostat installation on the user interface. Refer to "**10.7 Field settings/ROOM THERMOSTAT**".
- It is the installers' responsibility to ensure that no unwanted situations can occur (e.g. extremely high temperature water going towards floor heating loops, etc.)
- The supplier does not offer any type of mixing station. Dual set point control only provides the possibility to use two set points.
- When only zone A requests heating, zone B will be fed with water at a temperature equal to the first set point. This can lead to unwanted heating in zone B.
- When only zone B requests heating, the mixing station will be fed with water at a temperature equal to the second set point. Depending on the control of the mixing station, the floor heating loop can still receive water at a temperature equal to the set point of the mixing station.
- Be aware that the actual water temperature through the floor heating loops depends on the control and setting of the mixing station.

## 8.6 Application 6

Dual setpoint function application without room thermostat connect to the outdoor unit.

- Heating is provided through floor heating loops and fan coil units. The floor heating loops and fan coil units require different operating water temperatures.
- The floor heating loops require a lower water temperature in heating mode compared to fan coil units. To achieve these two set points, a mixing station is used to adapt the water temperature according to requirements of the floor heating loops. The fan coil units are directly connected to the unit water circuit and the floor heating loops are after the mixing station. The mixing station is controlled by the unit (or buy from the market, controlled by itself).

- The operation and configuration of the field water circuit is the responsibility of the installer.
- We only offer a dual set point control function. This function allows two set points to be generated. Depending on the required water temperature (floor heating loops and/or fan coil units are required) the first set point or second set point can be activated. See **10.7 field setting /TEMP. TYPE SETTING**.

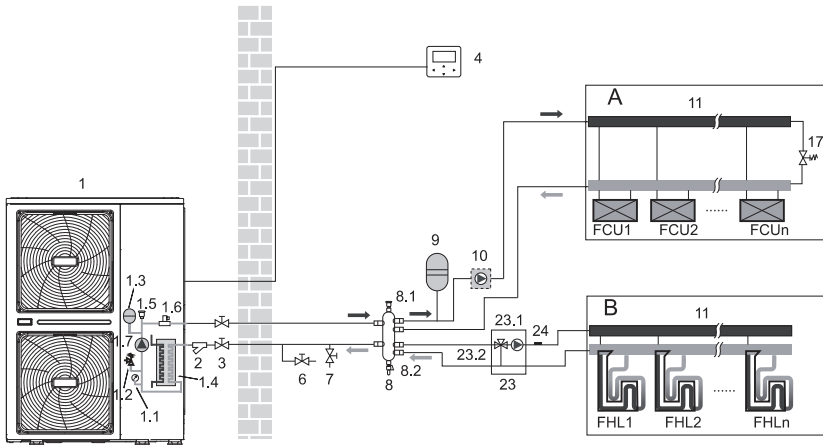

Coding	Assembly unit	Coding	Assembly unit
1	Outdoor unit	7	Fill valve (field supply)
1.1	Manometer	8	Balance tank (field supply)
1.2	Pressure relief valve	8.1	Air purge valve
1.3	Expansion vessel	8.2	Drain valve
1.4	Plate heat exchanger	9	Expansion vessel (field supply)
1.5	Air purge valve	10	P_o: Outside circulation pump (field supply)
1.6	Flow switch	11	Collector / distributor (field supply)
1.7	P_i: Circulation pump in the unit	17	Bypass valve (field supply)
2	Y-shape filter	23	Mixing station (field supply)
3	Stop valve (field supply)	23.1	P_c: zone 2 pump (field supply)
4	Wired controller	23.2	SV3: 3-way valve (field supply)
5A	Room thermostat for zone 1 (field supply)	24	Tw2: Zone 2 water flow temp. (individual purchase)
5B	Room thermostat for zone 2 (field supply)	FHL 1...n	Floor heating loop (field supply)
6	Drain valve (field supply)	FCU 1...n	Fan coil units (field supply)

#### NOTE

- The volume of balance tank(8) should be greater than 40L. The drain valve (6) should be installed at the lowest position of the system.
- As the temperature sensor attached in the user interface is used to detect the room temperature, the user interface (4) should be placed in the room where floor heating loops and fan coil units is installed and away from the heating source. Correct configuration should be applied in the user interface (refer to **10.7 field settings/TEMP. TYPE SETTING**). The first setpoint is water temperature which can be set on the main page of user interface, the second setpoint is calculated from climate related curves, the target outlet water temperature is the higher one of these two setpoints. The unit will turn off when the room temperature reaches the target temperature.

#### • Pump operation and space heating

The pump (1.7) and (10) will operate when there is request for heating for A and / or B. Pump (23.1) will operate when the room temperature of zone B is lower than the set point which set in the user interface. The outdoor unit will start operating to achieve the target water flow temperature.

## 8.7 Application 7

The units are installed in parallel and can be used for cooling, heating and hot water.

- 6 units can be connected in parallel. Please refer to 9.7.5 for the parallel system electrical control system connection diagram.
- The parallel system can control and view the operation of the entire system only by connecting the master to the wire controller;
- If the DHW function is required, the water tank can only be connected to the master unit water circuit through a three-way valve, and controlled by the master unit;
- If you need to link with AHS, the AHS can only be connected to the master waterway and controlled by the master unit;
- The connection and function of the terminal are the same as the single unit, please refer to the application 8.1-8.6;

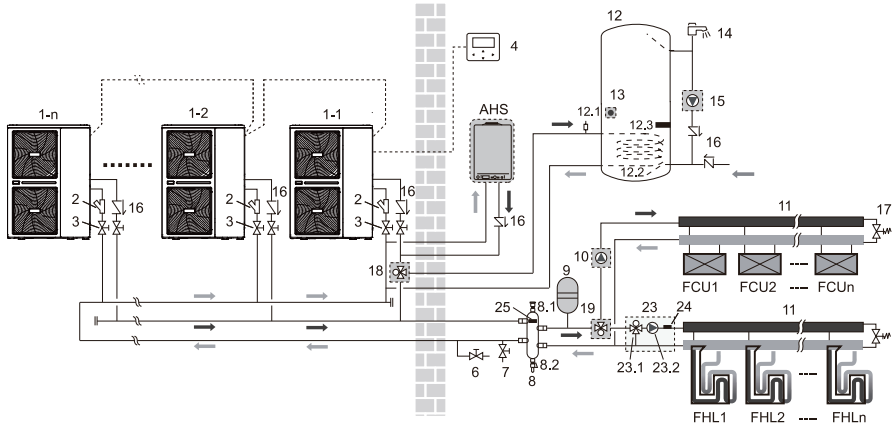

Coding	Assembly unit	Coding	Assembly unit
1-1	Outdoor unit: master	13	T5: DHW tank temp. sensor
1-2...1-n	Outdoor unit: slave	14	Hot water tap (field supply)
2	Y-shape filter	15	P_d: DHW pump (field supply)
3	Stop valve (field supply)	16	One way valve (field supply)
4	Wired controller	17	Bypass valve(field supply)
6	Drain valve (field supply)	18	SV1: 3-way valve (field supply)
7	Fill valve (field supply)	19	SV2: 3-way valve (field supply)
8	Balance tank (field supply)	23	Mixing station (field supply)
8.1	Air purge valve	23.1	SV3: 3-way valve (field supply)
8.2	Drain valve	23.2	P_c: zone 2 pump (field supply)
9	Expansion vessel (field supply)	24	Tw2: Zone 2 water flow temp. (individual purchase)
10	P_o: Outside circulation pump (field supply)	25	Tbt1: Balance tank temp. sensor (individual purchase)
11	Collector / distributor (field supply)	FHL 1...n	Floor heating loop (field supply)
12	Domestic hot water tank (field supply)	FCU 1...n	Fan coil units (field supply)
12.1	Air purge valve	AHS	Additional heating source(boiler) (field supply)
12.2	Heat exchanger coil	/	/
12.3	Booster heater	/	/

### NOTE

- The volume of balance tank(8) should be greater than  $(40 \times n)L$ . The drain valve (6) should be installed at the lowest position of the system.
- The water inlet and outlet pipe joints of each unit of the parallel system should be connected with soft connections, and one-way valves must be installed at the water outlet pipe;
- The Tbt1 temperature sensor must be installed in the parallel system (otherwise unit cannot be started), the temperature point is set in the balance tank (8).



## 9 OVERVIEW OF THE UNIT

### 9.1 Disassembling the unit

Door 1 To access to the compressor and electrical parts and hydraulic compartment

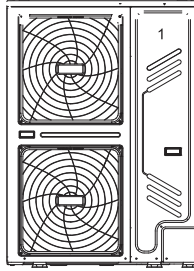

#### WARNING

- Switch off all power — i.e. unit power supply — before removing doors 1 .
- Parts inside the unit may be hot.

Push the grill to the left until it stops, then pull its right edge, so you can removed the grill. You can also reverse the procedure. Be careful to avoid hand injury.

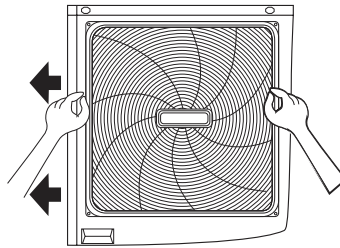
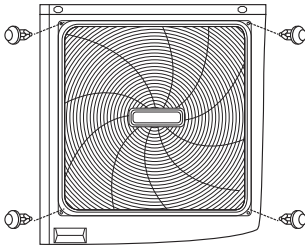

### 9.2 Main components

#### 9.2.1 Hydraulic module

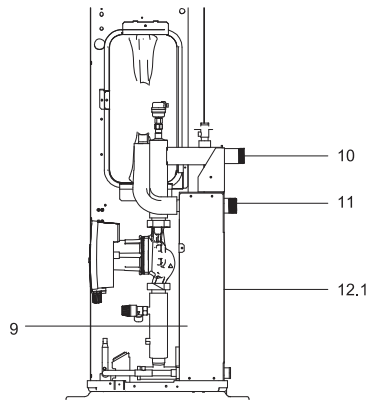
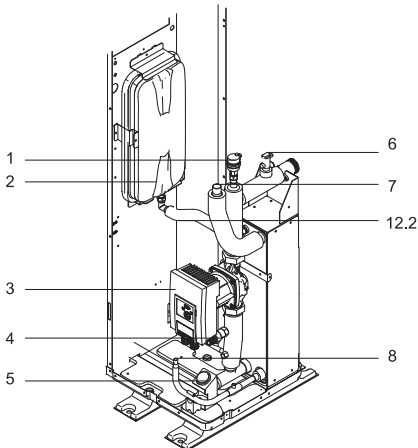

### 9.2.2 Hydraulic system diagram

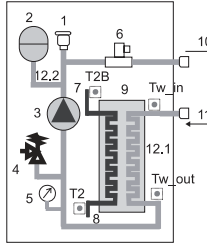

Coding	Assembly unit	Explanation
1	Air purge valve	Remaining air in the water circuit will be automatically removes air from the water circuit.
2	Expansion vessel	Balances water system pressure. (Expansion vessel volume: 8L)
3	Circulation pump	Circulates water in the water circuit.
4	Pressure relief valve	Prevents excessive water pressure by opening at 3 bar and discharging water from the water circuit.
5	Manometer	Provides water circuit pressure readout.
6	Flow switch	Detects water flow rate to protect compressor and water pump in the event of insufficient water flow.
7	Refrigerant gas connection	/
8	Refrigerant liquid connection	/
9	Plate heat exchanger	Transfer heat from the refrigerant to the water.
10	Water outlet connection	/
11	Water inlet connection	/
12.1	Electrical heating tape	For heating plate heat exchanger
12.2	Electrical heating tape	For heating connection pipe of expansion vessel
/	Temperature sensors	Four temperature sensors determine the water and refrigerant temperature at various points in the water circuit.(T2B; T2; Tw_out; Tw_in)

### 9.3 Electronic control box

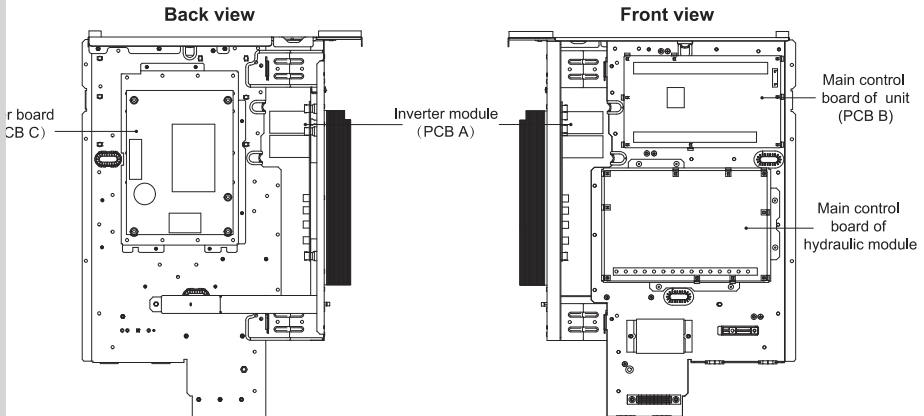

Note:The picture is for reference only, please refer to the actual product.

### 9.3.1 Main control board of indoor unit

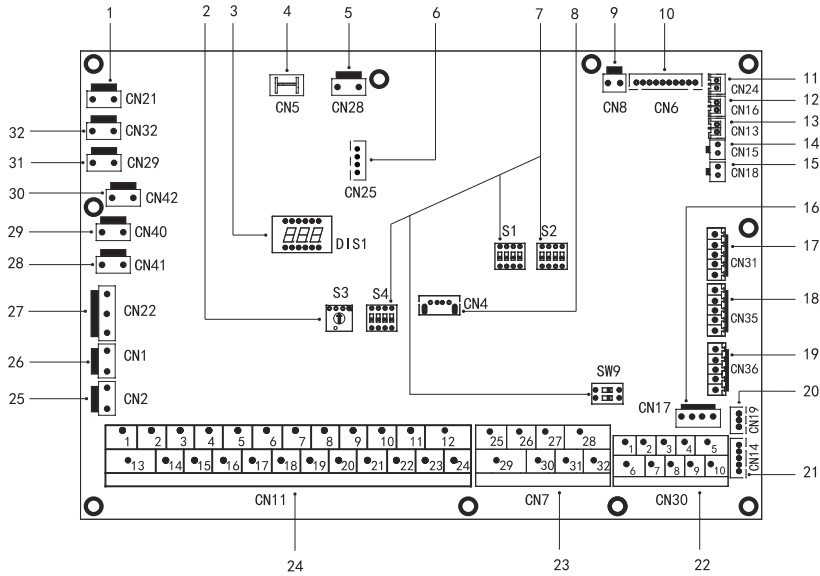

Order	Port	Code	Assembly unit	Order	Port	Code	Assembly unit
1	CN21	POWER	Port for power supply	19	CN36	M1 M2	Port for remote switch
2	S3	/	Rotary dip switch			T1 T2	Port for temperature board
3	DIS1	/	Digital display	20	CN19	P Q	Communicate port between indoor unit and outdoor unit
4	CN5	GND	Port for ground	21	CN14	A B X Y E	Port for communication with the wired controller
5	CN28	PUMP	Port for variable speed pump power input			1 2 3 4 5	Port for communication with the wired controller
6	CN25	DEBUG	Port for IC programming	22	CN30	6 7	Communicate port between indoor unit and outdoor unit
7	S1,S2,S4,SW9	/	Dip switch			9 10	Port for Internal machine Parallel
8	CN4	USB	Port for USB programming			26 30/31 32	Compressor run/Defrost run
9	CN8	FS	Port for flow switch	23	CN7	25 29	Port for antifreeze E-heating tape(external)
		T2	Port for temperature sensors of refrigerant liquid side temperature of indoor unit (heating mode)			27 28	Port for additional heat source
		T2B	Port for temperature sensors of refrigerant gas side temperature of indoor unit (cooling mode)			1 2	Input port for solar energy
		TW_in	Port for temperature sensors of inlet water temperature of plate heat exchanger			3 4 15	Port for room thermostat
		TW_out	Port for temperature sensors of outlet water temperature of plate heat exchanger			5 6 16	Port for SV1(3-way valve)
		T1	Port for temperature sensors of final outlet water temperature of indoor unit			7 8 17	Port for SV2(3-way valve)
11	CN24	Tbt1	Port for balanced water tank of up temp. sensor	24	CN11	9 21	Port for zone 2 pump
12	CN16	Tbt2	Port for balanced water tank of down temp. sensor			10 22	Port for outside circulation pump
13	CN13	T5	Port for domestic hot water tank temp. sensor			11 23	Port for solar energy pump
14	CN15	Tw2	Port for outlet water for zone 2 temp. sensor			12 24	Port for DHW pipe pump
15	CN18	Tsolar	Port for solar panel temp. sensor			13 16	Control port for tank booster heater
16	CN17	PUMP_BP	Port for variable speed pump communication			14 17	Control port for internal backup heater 1
		HT	Control port for room thermostat (heating mode)			18 19 20	Port for SV3(3-way valve)
		COM	Power port for room thermostat	25	CN2	TBHF_FB	Feedback port for external temperature switch(shorted in default)
		CL	Control port for room thermostat (cooling mode)	26	CN1	IBH1/2_FB	Feedback port for temperature switch (shorted in default)
		SG	Port for smart grid (grid signal)			IBH1	Control port for internal backup heater 1
		EVU	Port for smart grid (photovoltaic signal)	27	CN22	IBH2	Reserved
17	CN31					TBH	Control port for tank booster heater
18	CN35			28	CN41	HEAT8	Port for anti-freeze electric heating tape(internal)
				29	CN40	HEAT7	Port for anti-freeze electric heating tape(internal)
				30	CN42	HEAT6	Port for anti-freeze electric heating tape(internal)
				31	CN29	HEAT5	Port for anti-freeze electric heating tape(internal)
				32	CN32	IBH0	Port for backup heater

### 9.3.2 Inverter module

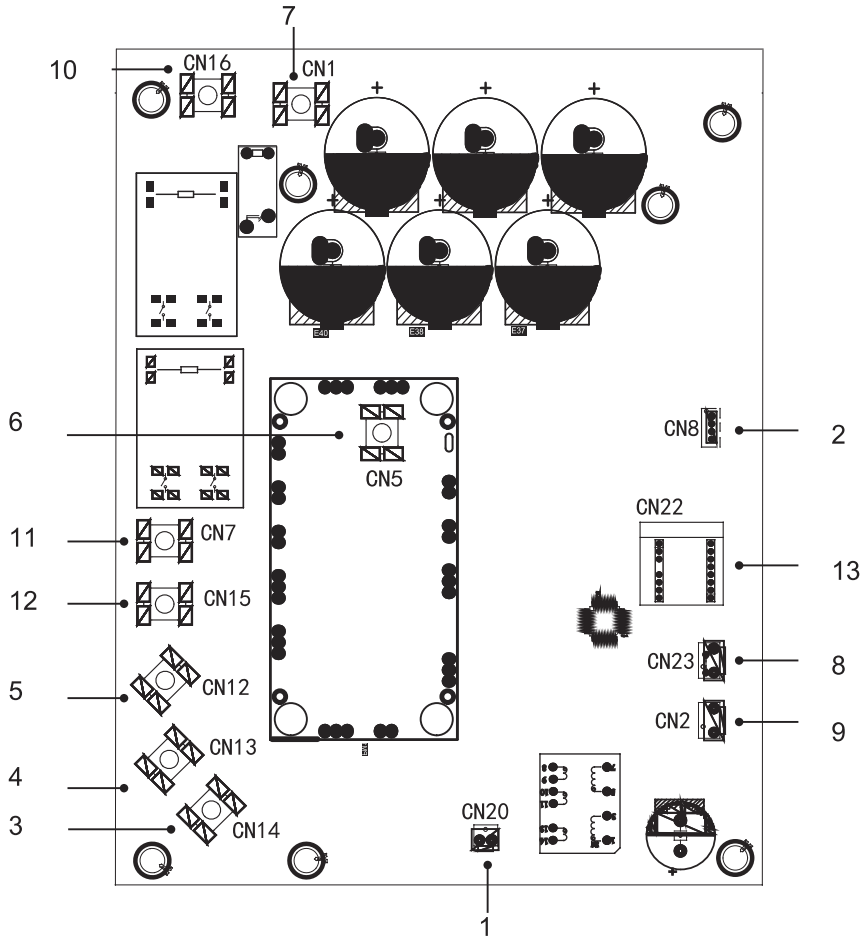

Coding	Assembly unit
1	Output port for +15V(CN20)
2	Port for communication with PCB B (CN8)
3	Compressor connection port W
4	Compressor connection port V
5	Compressor connection port U
6	Input port P_out for IPM module
7	Input port P_in for IPM module
8	Input port for high pressure switch (CN23)
9	Power for switching power supply(CN2)
10	Power filtering L1(L1')
11	Power filtering L2(L2')
12	Power filtering L3(L3')
13	PED board

### 9.3.3 Main control board of unit

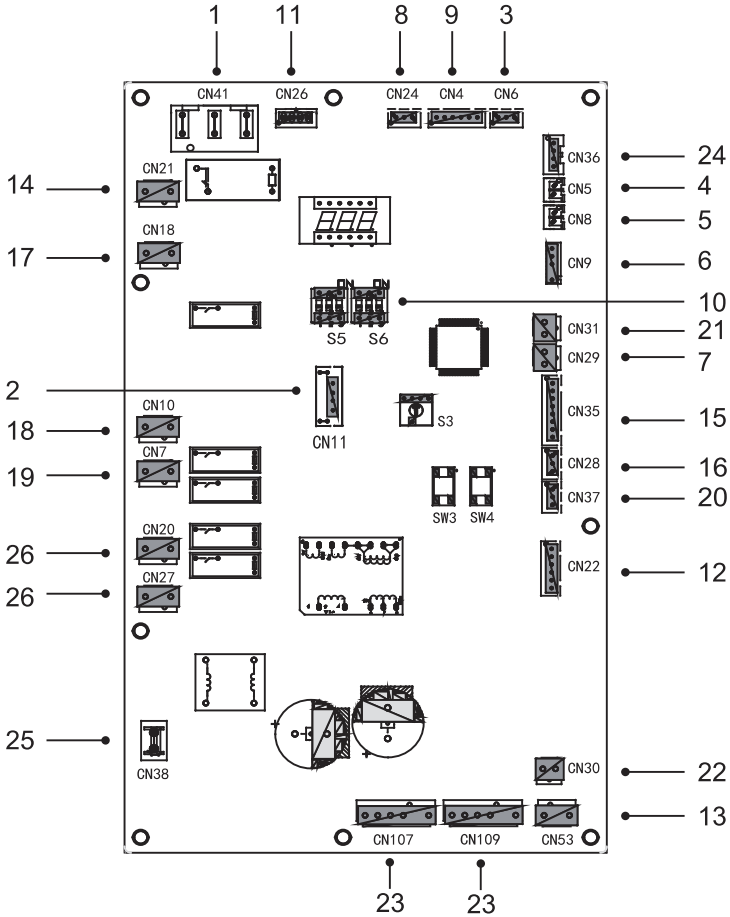

Coding	Assembly unit	Coding	Assembly unit
1	Power supply port for PCB B(CN41)	14	Power supply port for hydro-box control board(CN21)
2	Port for IC programming(CN11)	15	Port for other temp.sensor(CN35)
3	Port for pressure sensor(CN6)	16	Port for communication XYE(CN28)
4	Port for sunction temp.sensor(CN5)	17	Port for 4-way value(CN18)
5	Port for discharge temp.sensor(CN8)	18	Port for eletric heating tape1(CN10)
6	Port for outdoor ambient temp. sensor and condenser temp.sensor(CN9)	19	Port for eletric heating tape2(CN7)
7	Port for low pressure switch and quick check(CN29)	20	Port for communication D1D2E(CN37)
8	Port for communication with hydro-box control board (CN24)	21	Port for high pressure switch and quick check(CN31)
9	Port for communication with PCB C(CN4)	22	Port for fan 15VDC power supply(CN30)
10	DIP switch(S5,S6)	23	Port for fan(CN107/109)
11	Port for communication with Power Meter(CN26)	24	Port for communication with PCB A(CN36)
12	Port for electrical expansion value(CN22)	25	Port for GND(CN38)
13	Port for fan 310VDC power supply(CN53)	26	Port for SV(CN20/27)

### 9.3.3 Filter board

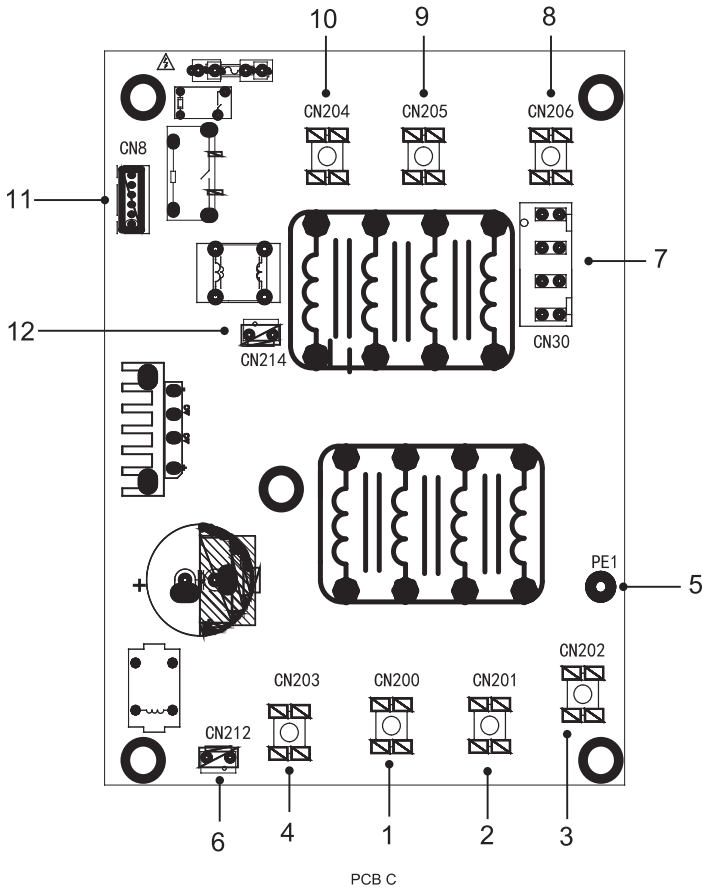

Coding	Assembly unit	Coding	Assembly unit
1	Power supply L3(L3)	7	Power supply port for main control board(CN30)
2	Power supply L2(L2)	8	Power filtering L1(L1')
3	Power supply L1(L1)	9	Power filtering L2(L2')
4	Power supply N(N)	10	Power filtering L3(L3')
5	Ground wire(PE1)	11	Port for communication with PCB B (CN8)
6	Power supply port for DC fan(CN212)	12	Power supply for PCB A switching power supply(CN214)

## 9.4 Water piping

All piping lengths and distances have been taken into consideration.

Requirements	Valve
The maximum allowed thermistor cable length is 20m. This is the maximum allowable distance between the domestic hot water tank and the unit (only for installations with a domestic hot water tank).The thermistor cable supplied with the domestic hot water tank is 10m in length.In order to optimize efficiency we recommend installing the 3-way valve and the domestic hot water tank as close as possible to the unit.	Thermistor cable length minus 2m

### NOTE

If the installation is equipped with a domestic hot water tank (field supply), please refer to the domestic hot water tank Installation And Owner's Manual. If there is no glycol (anti-freeze) in the system there is a power supply or pump failure, drain the system (as shown in the figure below).

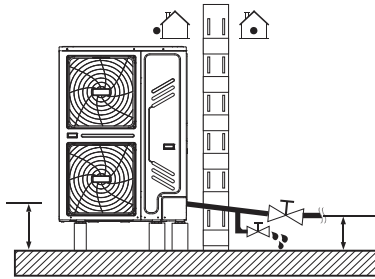

### NOTE

If water is not removed from the system in freezing weather when unit is not used. The frozen water may damage the water circle parts.

### 9.4.1 Check the water circuit

The units are equipped with a water inlet and outlet for connection to a water circuit.

The units should only be connected to closed water circuits. Connection to an open water circuit would lead to excessive corrosion of the water piping. Only materials complying with all applicable legislation should be used.

Example:

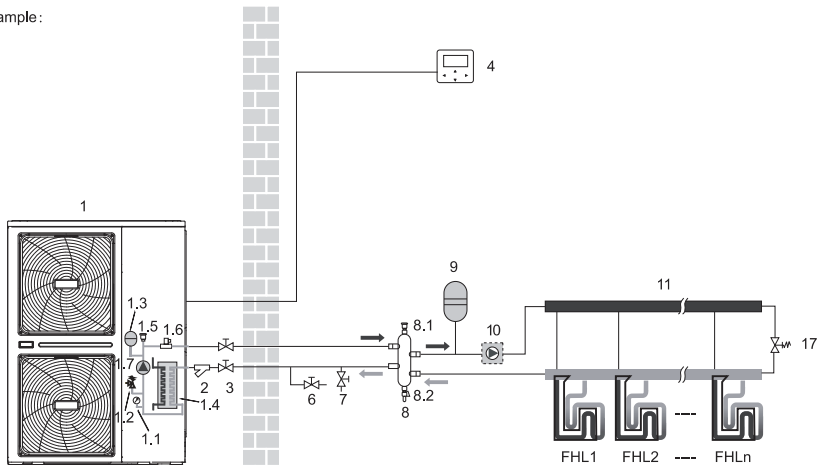

Before continuing installation of the unit, check the following:

- The maximum water pressure  $\leq 3$  bar.
- The maximum water temperature  $\leq 70^{\circ}\text{C}$  according to safety device setting.
- Always use materials that are compatible with the water used in the system and with the materials used in the unit.
- Ensure that components installed in the field piping can withstand the water pressure and temperature.
- Drain taps must be provided at all low points of the system to permit complete drainage of the circuit during maintenance.
- Air vents must be provided at all high points of the system. The vents should be located at points that are easily accessible for service. An automatic air purge is provided inside the unit. Check that this air purge valve is not tightened so that automatic release of air in the water circuit is possible.

### 9.4.2 Water volume and expansion vessel pre-pressure checks

The units are equipped with an expansion vessel (models: 8L) that has a default pre-pressure of 1.0 bar. To assure proper operation of the unit, the pre-pressure of the expansion vessel might need to be adjusted.

1) Check that the total water volume in the installation, excluding the internal water volume of the unit, is at least 40L . Refer to 14 Technical specifications to find the total internal water volume of the unit.

#### NOTE

- In most applications this minimum water volume will be satisfactory.
- In critical processes or in rooms with a high heat load though, extra water might be required.
- When circulation in each space heating loop is controlled by remotely controlled valves, it is important that this minimum water volume is kept even if all the valves are closed.

2) Using the table below, determine if the expansion vessel pre- pressure requires adjustment.

3) Using the table and instructions below, determine if the total water volume in the installation is below the maximum allowed water volume.

Installation height difference(*)	Water volume $\leq 230$ L	Water volume $>230$ L
$\leq 7$ m	No pre-pressure adjustment required.	Actions required: • Pre-pressure must be increased, calculate according to "Calculating the pre-pressure of the expansion vessel" below. • Check if the water volume is lower than maximum allowed water volume (use graph below)
$>7$ m	Actions required: • Pre-pressure must be increased, calculate according to "Calculating the pre-pressure of the expansion vessel" below. • Check if the water volume is lower than maximum allowed water volume (use graph below)	Expansion vessel of the unit too small for the installation.

\* Height difference is between the highest point of the water circuit and the outdoor unit's expansion tank. Unless the unit is located at the highest point of the system, in which case the installation height difference is considered to be zero.

### Calculating the pre-pressure of the expansion vessel

The pre-pressure (Pg) to be set depends on the maximum installation height difference (H) and is calculated as follows:  
 $Pg(\text{bar}) = (H(\text{m})/10 + 0.3)$  bar

### Checking the maximum allowed water volume

To determine the maximum allowed water volume in the entire circuit, proceed as follows:



- Determine the calculated pre-pressure ( $P_g$ ) for the corresponding maximum water volume using the graph below.
- Check that the total water volume in the entire water circuit is lower than this value. If this is not the case, the expansion vessel inside the unit is too small for the installation.

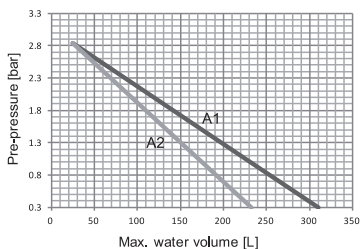

Pre-pressure = pre-pressure of the expansion vessel  
 Maximum water volume = maximum water volume in the system

A1 System without glycol

A2 System without 25% propylene glycol

### Example 1 :

The unit is installed 5m below the highest point in the water circuit. The total water volume in the water circuit is 100 L. In this example, no action or adjustment is required.

### Example 2 :

The unit is installed at the highest point in the water circuit. The total water volume in the water circuit is 250 L.

Result:

- Since 250 L is more than 230 L, the pre-pressure must be decreased (see table above).
- The required pre-pressure is:  $P_g(\text{bar}) = (H(m)/10+0.3) \text{ bar} = (0/10+0.3) \text{ bar} = 0.3 \text{ bar}$
- The corresponding maximum water volume can be read from the graph: approximately 310L.
- Since the total water volume (250L) is below the maximum water volume (310L), the expansion vessel suffices for the installation.

Setting the pre-pressure of the expansion vessel

When it is required to change the default pre-pressure of the expansion vessel (1.0 bar), following guidelines:

- Use only dry nitrogen to set the expansion vessel pre-pressure.
- Inappropriate setting of the expansion vessel pre-pressure will lead to malfunctioning of the system. Pre-pressure should only be adjusted by a licensed installer.

Selecting the additional expansion vessel

If the expansion vessel of the unit is too small for the installation, an additional expansion vessel is needed.

- calculate the pre-pressure of the expansion vessel:  $P_g(\text{bar})=(H(m)/10+0.3) \text{ bar}$   
 the expansion vessel equipped in the unit should adjust the pre- pressure also.
- calculate the volume needed of the additional expansion vessel:  
 $V1=0,0693 \cdot V_{\text{water}}/(2,5-P_g)-V0$   
 $V_{\text{water}}$  is volume of water in the system,  $V0$  is volume of expansion vessel which the unit is equipped(8L).

### 9.4.3 Water circuit connection

Water connections must be made correctly in accordance with labels on the outdoor unit, with respect to the water inlet and water outlet.

#### CAUTION

Be careful not to deform the unit's piping by using excessive force when connecting the piping. Deforming the pipe can cause the unit to malfunction.

If air, moisture or dust gets in the water circuit, problems may occur. Therefore, always take into account the following when connecting the water circuit:

- Use clean pipes only.
- Hold the pipe end downwards when removing burrs.
- Cover the pipe end when inserting it through a wall to prevent dust and dirt entering.
- Use a good thread sealant for sealing the connections. The sealing must be able to withstand the pressures and temperatures of the system.
- When using non-copper metallic piping, be sure to insulate two kind of materials from each other to prevent galvanic corrosion.
- For copper is a soft material, use appropriate tools for connecting the water circuit. Inappropriate tools will cause damage to the pipes.

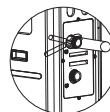

#### NOTE

The unit is only to be used in a closed water system. Application in an open water circuit can lead to excessive corrosion of the water piping:

- Never use Zn-coated parts in the water circuit. Excessive corrosion of these parts may occur as copper piping is used in the unit's internal water circuit.
- When using a 3-way valve in the water circuit. Preferably choose a ball type 3-way valve to guarantee full separation between the domestic hot water and floor heating water circuit.
- When using a 3-way valve or a 2-way valve in the water circuit. The recommended maximum changeover time of the valve should be less than 60 seconds.

### 9.4.4 Water circuit anti-freeze protection

Ice formation can cause damage to the hydraulic system. As the outdoor unit may be exposed to sub-zero temperatures, care must be taken to prevent freezing of the system.

All internal hydronic parts are insulated to reduce heat loss. Insulation must also be added to the field piping.

The software contains special functions using the heat pump to protect the entire system against freezing. When the temperature of the water flow in the system drops to a certain value, the unit will heat the water, either using the heat pump, the electric heating tap, or the backup heater. The freeze protection function will turn off only when the temperature increases to a certain value.

In event of a power failure, the above features would not protect the unit from freezing.

Do one of the following to protect the water circuit against freezing:

- Add glycol to the water. Glycol lowers the freezing point of the water.
- Install freeze protection valves. Freeze protection valves drain the water from the system before it can freeze.

#### NOTE

If you add glycol to the water, do NOT install freeze protection valves. Possible consequence: Glycol leaking out of the freeze protection valves.

### 1. Freeze protection by glycol

#### About freeze protection by glycol

Adding glycol to the water lowers the freezing point of water.

#### WARNING

Ethylene glycol is toxic.



#### WARNING

Due to the presence of glycol, corrosion of the system is possible. Uninhibited glycol will turn acidic under the influence of oxygen. This process is accelerated by the presence of copper and high temperatures. The acidic uninhibited glycol attacks metal surfaces and forms galvanic corrosion cells that cause severe damage to the system. Therefore it is important that:

- the water treatment is correctly executed by a qualified water specialist,
- a glycol with corrosion inhibitors is selected to counteract acids formed by the oxidation of glycols,
- no automotive glycol is used because their corrosion inhibitors have a limited lifetime and contain silicates which can foul or plug the system,
- galvanized pipes are NOT used in glycol systems since the presence may lead to the precipitation of certain components in the glycol's corrosion inhibitor.

#### NOTE

Glycol absorbs water from its environment. Therefore do NOT add glycol that has been exposed to air. Leaving the cap off the glycol container causes the concentration of water to increase. The glycol concentration is then lower than assumed. As a result, the hydraulic components might freeze up after all. Take preventive actions to ensure a minimal exposure of the glycol to air.

#### Types of glycol

The types of glycol that can be used depend on whether the system contains a domestic hot water tank:

If the system contains a domestic hot water tank, then only use propylene glycol\*;

If the system does NOT contain a domestic hot water tank, then you can use either propylene glycol\* or ethylene glycol;

\*Propylene glycol, including the necessary inhibitors, classified as Category III according to EN1717.

#### Required concentration of glycol

The required concentration of glycol depends on the lowest expected outdoor temperature, and on whether you want to protect the system from bursting or from freezing. To prevent the system from freezing, more glycol is required.

Add glycol according to the table below:

#### Ethylene Glycol

Quality of glycol	Modification coefficient				Minimum outdoor temperature
	Cooling capacity modification	Power modification	Water resistance	Water flow modification	
0%	1.000	1.000	1.000	1.000	0 °C
10%	0.984	0.998	1.118	1.019	-5 °C
20%	0.973	0.995	1.268	1.051	-15 °C
30%	0.965	0.992	1.482	1.092	-25 °C

#### Propylene Glycol

Quality of glycol	Modification coefficient				Minimum outdoor temperature
	Cooling capacity modification	Power modification	Water resistance	Water flow modification	
0%	1.000	1.000	1.000	1.000	0 °C
10%	0.976	0.996	1.071	1.000	-4 °C
20%	0.961	0.992	1.189	1.016	-12 °C
30%	0.948	0.988	1.380	1.034	-20 °C

## INFORMATION

- Protection against bursting: the glycol will prevent the piping from bursting, but NOT the liquid inside the piping from freezing.
- Protection against freezing: the glycol will prevent the liquid inside the piping from freezing.

## NOTE

- The required concentration might differ depending on the type of glycol. ALWAYS compare the requirements from the table above with the specifications provided by the glycol manufacturer. If necessary, meet the requirements set by the glycol manufacturer.
- If the liquid in the system is frozen, the pump will NOT be able to start. Mind that if you only prevent the system from bursting, the liquid inside might still freeze.
- When water is at standstill inside the system, the system is very likely to freeze and get damaged.

## 2. Freeze protection by freeze protection valves

### About freeze protection valves

When no glycol is added to the water, you can use freeze protection valves to drain the water from the system before it can freeze.

- Install freeze protection valves (field supply) at all lowest points of the field piping.
- Normally closed valves (located indoors near the piping entry/exit points) can prevent that all water from indoor piping is drained when the freeze protection valves open.

## NOTE

Water may enter into the flow switch and cannot be drained out and may freeze when the temperature is low enough. The flow switch should be removed and dried, then can be reinstalled in the unit.

Counterclockwise rotation, remove the flow switch.

Drying the flow switch completely.

Also refer to "10.3 Pre-operation checks/Checks before initial start-up".

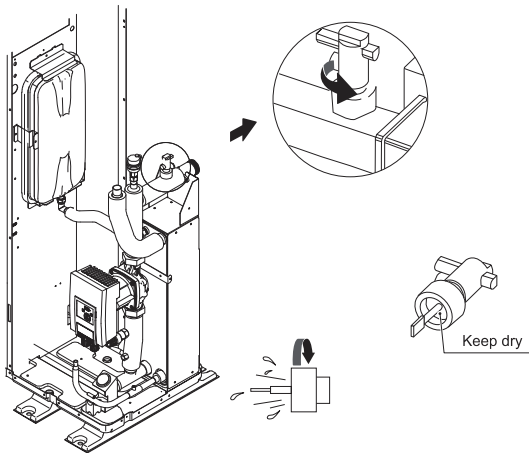

## 9.5 Adding water

Connect the water supply to the fill valve and open the valve.

Make sure the automatic air purge valve is open (at least 2 turns).

Fill with water until the manometer indicates a pressure of approximately 2.0 bar. Remove air in the circuit as much as possible using the air purge valves. Air in the water circuit could lead to malfunction of the backup electric heater.

Do not fasten the black plastic cover on the vent valve at the topside of the unit when the system is running. Open air purge valve, turn anticlockwise at least 2 full turns to release air from the system.

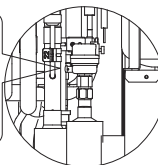

## NOTE

During filling, it might not be possible to remove all air in the system. Remaining air will be removed through the automatic air purge valves during the first operating hours of the system. Topping up the water afterwards might be required.

- The water pressure indicated on the manometer will vary depending on the water temperature (higher pressure at higher water temperature). However, at all times water pressure should remain above 0.3 bar to avoid air entering the circuit.
- The unit might drain-off too much water through the pressure relief valve.
- Water quality should be complied with EN 98/83 EC Directives.  
Detailed water quality condition can be found in EN 98/83 EC Directives.

## 9.6 Water piping insulation

The complete water circuit including all piping, water piping must be insulated to prevent condensation during cooling operation and reduction of the heating and cooling capacity as well as prevention of freezing of the outside water piping during winter. The insulation material should at least of B1 fire resistance rating and complies with all applicable legislation. The thickness of the sealing materials must be at least 13 mm with thermal conductivity 0,039 W/mK in order to prevent freezing on the outside water piping.

If the outdoor ambient temperature is higher than 30°C and the humidity is higher than RH 80%, then the thickness of the sealing materials should be at least 20 mm in order to avoid condensation on the surface of the seal.

## 9.7 Field wiring

### WARNING

A main switch or other means of disconnection, having a contact separation in all poles, must be incorporated in the fixed wiring in accordance with relevant local laws and regulations. Switch off the power supply before making any connections. Use only copper wires. Never squeeze bundled cables and make sure they do not come in contact with the piping and sharp edges. Make sure no external pressure is applied to the terminal connections. All field wiring and components must be installed by a licensed electrician and must comply with relevant local laws and regulations.

The field wiring must be carried out in accordance with the wiring diagram supplied with the unit and the instructions given below.

Be sure to use a dedicated power supply. Never use a power supply shared by another appliance.

Be sure to establish a ground. Do not ground the unit to a utility pipe, surge protector, or telephone ground. Incomplete grounding may cause electrical shock.

Be sure to install a ground fault circuit interrupter (30 mA). Failure to do so may cause electrical shock.

Be sure to install the required fuses or circuit breakers.

### 9.7.1 Precautions on electrical wiring work

- Fix cables so that cables do not make contact with the pipes (especially on the high pressure side).
- Secure the electrical wiring with cable ties as shown in figure so that it does not come in contact with the piping, particularly on the high-pressure side.
- Make sure no external pressure is applied to the terminal connectors.
- When installing the ground fault circuit interrupter make sure that it is compatible with the inverter (resistant to high frequency electrical noise) to avoid unnecessary opening of the ground fault circuit interrupter.

### NOTE

The ground fault circuit interrupter must be a high-speed type breaker of 30 mA (<0,1 s).

- This unit is equipped with an inverter. Installing a phase advancing capacitor not only will reduce the power factor improvement effect, but also may cause abnormal heating of the capacitor due to high-frequency waves. Never install a phase advancing capacitor as it could lead to an accident.

### 9.7.2 Wiring overview

The illustration below gives an overview of the required field wiring between several parts of the installation. Refer also to "8 Typical application examples".

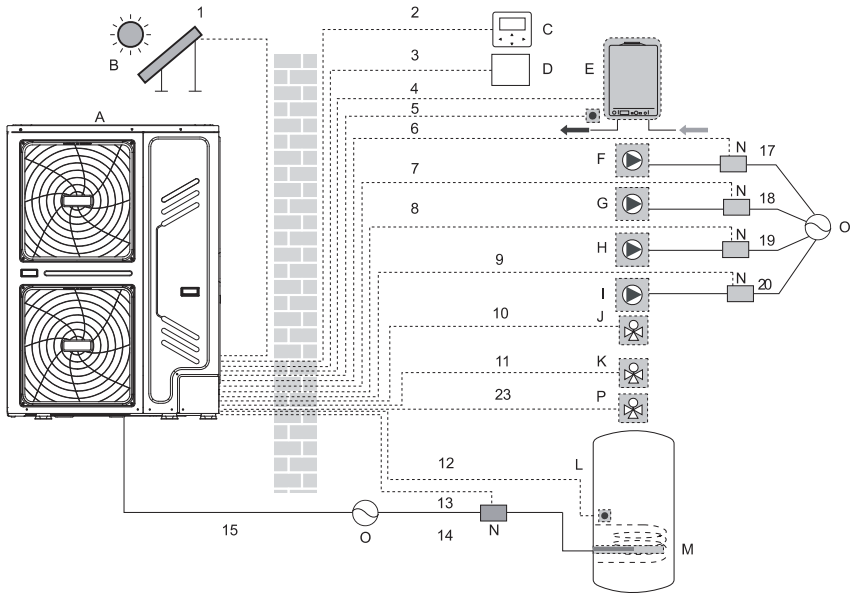

Coding	Assembly unit	Coding	Assembly unit
A	Outdoor unit	I	P_d: DHW pump (field supply)
B	Solar energy kit (field supply)	J	SV2: 3-way valve (field supply)
C	User interface	K	SV1: 3-way valve for domestic hot water tank (field supply)
D	Room thermostat (field supply)	L	Domestic hot water tank
E	Boiler (field supply)	M	Booster heater
F	P_s: Solar pump (field supply)	N	Contacteur
G	P_c: Circulation pump / zone 2 pump (field supply)	O	Power supply
H	P_o: Outside circulation pump / zone 1 pump (field supply)	P	Zone2 SV3(3-way valve)

Item	Description	AC/DC	Required number of conductors	Maximum running current
1	Solar energy kit signal cable	AC	2	200mA
2	User interface cable	AC	5	200mA
3	Room thermostat cable	AC	2 or 3	200mA(a)
4	Boiler control cable	/	2	200mA
5	Thermistor cable for Tw2	DC	2	(b)
9	DHW pump control cable	AC	2	200mA(a)
10/11/23	3-way valve control cable	AC	2 or 3	200mA(a)
12	Thermistor cable for T5	DC	2	(b)
13	Booster heater control cable	AC	2	200mA(a)
15	Power supply cable for unit	AC	3+GND	(c)

(a) Minimum cable section AWG18 (0.75mm<sup>2</sup>).

(b) The thermistor and connection wire (10m) are delivered with the domestic hot water tank (T5) or zone 2 outlet temp. (Tw2)

(c) See **9.7.4 Specifications of standard wiring components**

## NOTE

Please use H07RN-F for the power wire, all the cable are connected to high voltage except for thermistor cable and cable for user interface.

- Equipment must be grounded.
- All high-voltage external load, if it is metal or a grounded port, must be grounded.
- All external load current is needed less than 0.2A, if the single load current is greater than 0.2A, the load must be controlled through AC contactor.
- AHS1" "AHS2", "A1" "A2", "R1" "R1" and "DTF1" "DTF2" wiring terminal ports provide only the switch signal. Please refer to image of 9.7.6 to get the ports position in the unit.
- Expansion valve E-Heating tape, Plate heat exchanger E-Heating tape and Flow switch E-Heating tape share a control port.

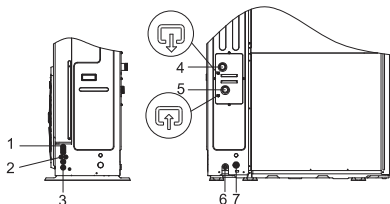

Coding	Assembly unit
1	High voltage wire hole
2	Low voltage wire hole
3	High voltage or low voltage wire hole
4	Water outlet
5	Water inlet
6	Drain outlet
7	Drainage pipe hole (for safety valve)

### Field wiring guidelines

- Most field wiring on the unit is to be made on the terminal block inside the switch box. To gain access to the terminal block, remove the switch box service panel .

## WARNING

Switch off all power including the unit power supply and backup heater and domestic hot water tank power supply (if applicable) before removing the switch box service panel.

- Fix all cables using cable ties.
- A dedicated power circuit is required for the backup heater.
- Installations equipped with a domestic hot water tank (field supply) require a dedicated power circuit for the booster heater. Please refer to the domestic hot water tank Installation & Owner's Manual. Secure the wiring in the order shown below.
- Lay out the electrical wiring so that the front cover does not rise up when doing wiring work and attach the front cover securely.
- Follow the electric wiring diagram for electrical wiring works (the electric wiring diagrams are located on the rear side of door 2.
- Install the wires and fix the cover firmly so that the cover may be fit in properly.

### 9.7.3 Precautions on wiring of power supply

- Use a round crimp-style terminal for connection to the power supply terminal board. In case it cannot be used due to unavoidable reasons, be sure to observe the following instructions.
- Do not connect different gauge wires to the same power supply terminal. (Loose connections may cause overheating.)
- When connecting wires of the same gauge, connect them according to the figure below.

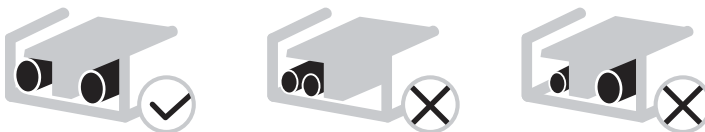

- Use the correct screwdriver to tighten the terminal screws. Small screwdrivers can damage the screw head and prevent appropriate tightening.
- Over-tightening the terminal screws can damage the screws.
- Attach a ground fault circuit interrupter and fuse to the power supply line.
- In wiring, make certain that prescribed wires are used, carry out complete connections, and fix the wires so that outside force cannot affect the terminals.

System	Outdoor unit				Power Current			Compressor		OFM	
	Voltage	Hz	Min.(V)	Max.(V)	MCA(A)	TOCA(A)	MFA(A)	MSC(A)	RLA(A)	kW	FLA(A)
18kW	380-415	50	342	456	21.0	28	25	-	12	0.34	3.0
22kW	380-415	50	342	456	24.5	28	25	-	14	0.34	3.0
26kW	380-415	50	342	456	27.0	28	32	-	18	0.34	3.0
30kW	380-415	50	342	456	28.5	28	32	-	21	0.34	3.0

### 9.7.4 Specifications of standard wiring components

Door 1: compressor compartment and electrical parts: XT1

#### OUTDOOR UNIT POWER SUPPLY

Unit	18kW	22kW	26kW	30kW
Maximum overcurrent protector(MOP)	18	21	24	28
Wiring size(mm <sup>2</sup> )	6	6	6	6

- Stated values are maximum values (see electrical data for exact values).

#### NOTE

The ground fault circuit interrupter must be a high-speed type breaker of 30 mA (<0.1 s).

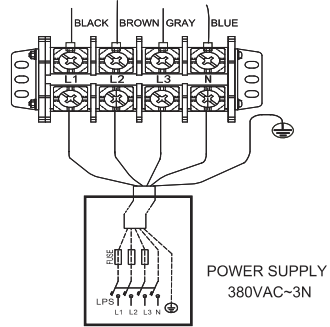

### 9.7.5 Connection for system parallel

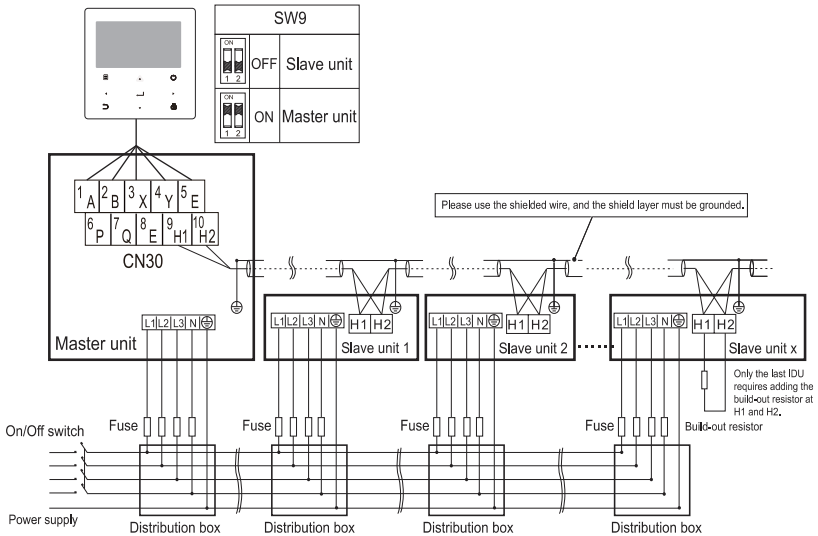

The parallel system electrical control system connection diagram(3N~)

#### CAUTION

- The parallel function of the system only supports 6 machines at most .
- In order to ensure the success of automatic addressing, all machines must be connected to the same power supply and powered on uniformly.
- Only the Master unit can connect the controller, and you must put the SW9 to "on" of the master unit, the slave unit cannot connect the controller .
- Please use the shielded wire, and the shield layer must be grounded.





## 2) For room thermostat

### a. type 1(RT1) (High voltage)

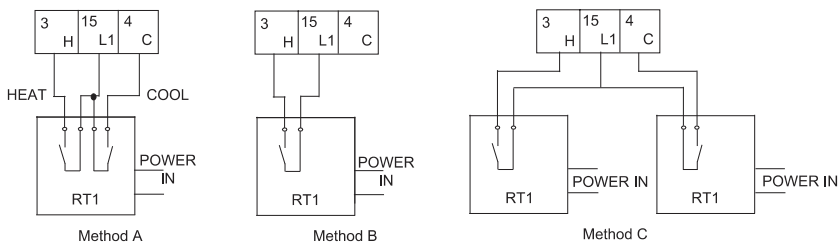

### b. type 2(RT1) (Low voltage): in main control board of hydraulic module CN31

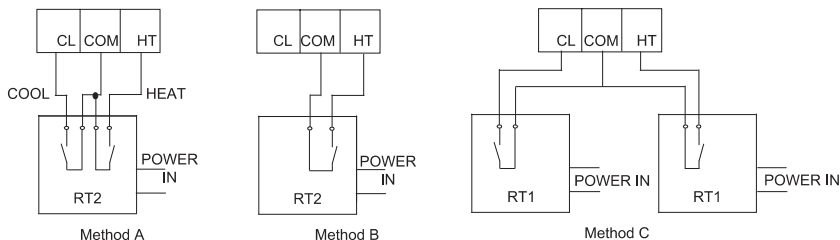

#### NOTE

There are two optional connect method depend on the room thermostat type.

Voltage	220-240VAC
Maximum running current(A)	0.2
Wiring size(mm <sup>2</sup> )	0.75

Room thermostat type1(RT1)(High voltage): "POWER IN" provide the working voltage to the RT, doesn't provide the voltage to the RT connector directly. Port "15 L1" provide the 220V voltage to the RT connector. Port "15 L1" connect from the unit main power supply port L of 1-phase power supply, L2 port of 3-phase power supply.

Room thermostat type2(RT2)(Low voltage): "POWER IN" provide the working voltage to the RT.

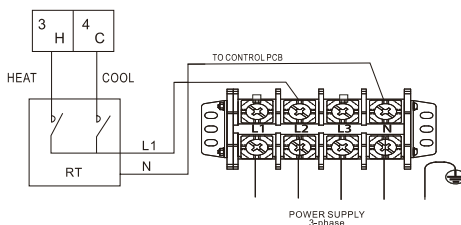

There are three methods for connecting the thermostat cable (as described in the picture above) and it depends on the application.

#### • Method A

RT can control heating and cooling individually, like the controller for 4-pipe FCU. When the hydraulic module is connected with the external temperature controller, user interface FOR SERVICEMAN set THERMOSTAT and ROOM MODE SETTING to YES:

- A.1 When unit detect voltage is 230VAC between C and N, the unit operates in the cooling mode.
- A.2 When unit detect voltage is 230VAC between H and N, the unit operates in the heating mode.
- A.3 When unit detect voltage is 0VAC for both side(C-N, H-N) the unit stop working for space heating or cooling.
- A.4 When unit detect voltage is 230VAC for both side(C-N, H-N) the unit working in cooling mode.

#### • Method B

RT provide the switch signal to unit. user interface FOR SERVICEMAN set ROOM THERMOSTAT and MODE SETTING to YES:

- B.1 When unit detect voltage is 230VAC between H and N, unit turn on.
- B.2 When unit detect voltage is 0VAC between H and N, unit turn off.

**NOTE**

When ROOM THERMOSTAT is set to YES, the indoor temperature sensor Ta can't be set to valid, unit running only according to T1.

**• Method C**

Hydraulic module is connected with two external temperature controllers, while user interface FOR SERVICEMAN set DUAL ROOM THERMOSTAT to YES:

- C.1 When unit detect voltage is 230VAC between H and N, the MAIN side turn on. When unit detect voltage is 0VAC between H and N, the MAIN side turn off.
- C.2 When unit detect voltage is 230VAC between C and N, the ROOM side turn on according to climate temp curve. When unit detect voltage is 0V between C and N, the ROOM side turn off.
- C.3 When H-N and C-N are detected as 0VAC, unit turn off.
- C.4 when H-N and C-N are detected as 230VAC, both MAIN and ROOM side turn on.

**NOTE**

- The wiring of the thermostat should correspond to the settings of the user interface. Refer to 10.7 Field setting/Room Thermostat.
- Power supply of machine and room thermostat must be connected to the same Neutral Line and (L2) Phase Line(for 3-phase unit only).

**Procedure**

- Connect the cable to the appropriate terminals as shown in the picture.
- Fix the cable with cable ties to the cable tie mountings to ensure stress relief.

**3) For 3-way value SV3**

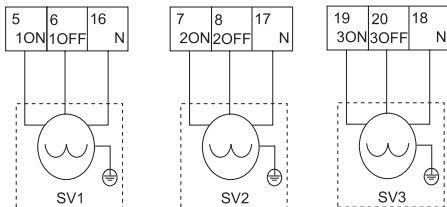

Voltage	220-240VAC
Maximum running current(A)	0.2
Wiring size(mm <sup>2</sup> )	0.75
Control port signal type	Type 1

**NOTE**

Wiring of the 3-way valve is different for NC(normal close) and NO (normal open). Before wiring, read the Installation & Owner's manual for the 3-way valve carefully and install the valve as showed in the picture. Make sure to connect it to the correct terminal numbers.

**Procedure**

- Connect the cable to the appropriate terminals as shown in the picture.
- Fix the cable reliably.

**4) For different functions pumps :**

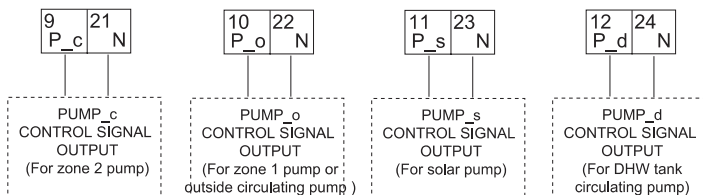

Voltage	220-240VAC
Maximum running current(A)	0.2
Wiring size(mm <sup>2</sup> )	0.75
Control port signal type	Type 2

**Procedure**

- Connect the cable to the appropriate terminals as shown in the picture.
- Fix the cable reliably.

**5) For tank booster heater:**

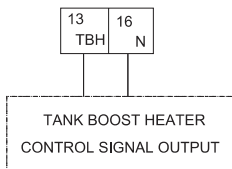

Voltage	220-240VAC
Maximum running current(A)	0.2
Wiring size(mm <sup>2</sup> )	0.75
Control port signal type	Type 2

Connection of the booster heater cable depends on the application. Only when the domestic hot water tank is installed will this wiring be needed. The unit only sends a turn on/off signal to the booster heater. An additional circuit breaker is needed and a dedicated terminal is needed to supply power to the booster heater.

See also "8 Typical application examples" and "10.7 Field settings/DHW control" for more information.

**Procedure**

- Connect the cable to the appropriate terminals as shown in the picture.
- Fix the cable with cable ties to the cable tie mountings to ensure stress relief.

**6) For external backup heater kit (optional)**

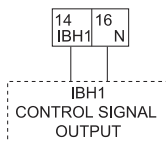

Voltage	220-240VAC
Maximum running current(A)	0.2
Wiring size(mm <sup>2</sup> )	0.75
Control port signal type	Type 2

**7) For antifreeze e-heating tape (external)**

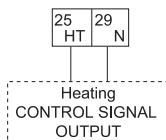

Voltage	220-240VAC
Maximum running current(A)	0.2
Wiring size(mm <sup>2</sup> )	0.75
Control port signal type	Type 2

**8) For unit running state output**

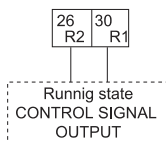

Voltage	220-240VAC
Maximum running current(A)	0.2
Wiring size(mm <sup>2</sup> )	0.75
Control port signal type	Type 2

**9) For additional heat source control:**

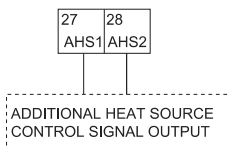

Voltage	220-240VAC
Maximum running current(A)	0.2
Wiring size(mm <sup>2</sup> )	0.75
Control port signal type	Type 2

## 10) For defrosting signal output:

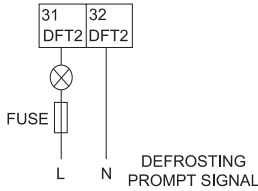

Voltage	220-240VAC
Maximum running current(A)	0.2
Wiring size(mm <sup>2</sup> )	0.75
Control port signal type	Type 1

## 11) For wired controller:

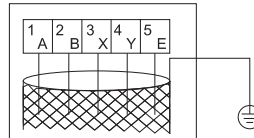
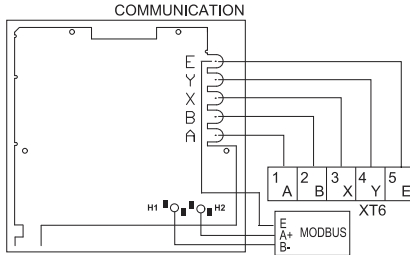

"PLEASE USE SHIELDED WIRE AND EARTH THE WIRE."

Wire type	5 wire shielded cable
Wire section(mm <sup>2</sup> )	0.75-1.25
Maximum wire length(m)	50

### NOTE

This equipment supports MODBUS RTU communication protocol.

As described above, during wiring, port A in the unit terminal XT6 corresponds to port A in the user interface. Port B corresponds to port B. Port X corresponds to port X. Port Y corresponds to port Y, and port E corresponds to port E.

### Procedure

- Remove the rear part of the user interface.
- Connect the cable to the appropriate terminals as shown in the picture.
- Reattach the rear part of the user interface.

## 12) For other functional ports

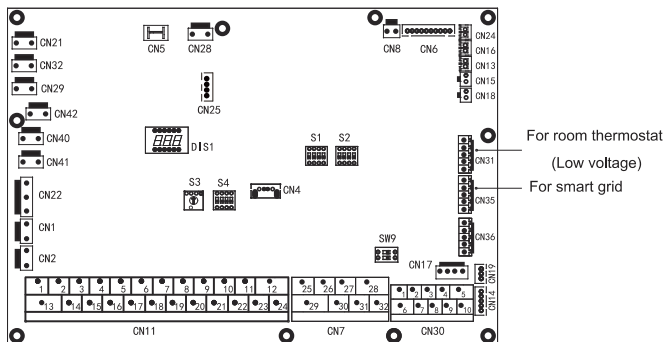

### a. For room thermostat (Low voltage): see 9.7.6 2) for room thermostat

### b. For smart grid:

The unit has smart grid function, there are two ports on PCB to connect SG signal and EVU signal as following:

- When EVU signal is on , and SG signal is on, as long as the DHW mode is set to be valid, heat pump will operate DHW mode priority and the DHW mode setting temperature will be change to 70 C .  $T5 < 69 C$  , the TBH is on,  $T5 \geq 70 C$  , the TBH is off.
- When EVU signal is on , and SG signal is off, as long as the DHW mode is set to be valid and the mode is on, heat pump will operate DHW mode priority.  $T5 < T5S-2$  , the TBH is on,  $T5 \geq T5S+3$  , the TBH is off.
- When EVU signal is off, and SG signal is on, the unit operates normally.
- When EVU signal is off, and SG signal is off, the unit operates as below: The unit will not operate DHW mode, and the TBH is invalid, disinfect function is invalid. The max running time for cooling/heating is "SG RUNNING TIME", then unit will be off.

# 10 START-UP AND CONFIGURATION

The unit should be configured by the installer to match the installation environment (outdoor climate, installed options, etc.) and user expertise.

## ⚠ CAUTION

It is important that all information in this chapter is read sequentially by the installer and that the system is configured as applicable.

### 10.1 Climate related curves

The Climate related curves can be selected in the user interface. Once the curve is selected, the target outlet temperature. In each mode, user can select one curve from curves in the user interface(curve can't be selected if dual room thermostat function is enabled.

It's possible to select curves even dual room thermostat function is enabled.

The relationship between outdoor temperature (T4/°C) and the target water temperature(T1S/°C) is described in the table and picture in the next page. )

1.The environment temperature curves of the low temperature setting for heating mode and ECO heating mode

T4	≤-20	-19	-18	-17	-16	-15	-14	-13	-12	-11	-10	-9	-8	-7	-6	-5	-4	-3	-2	-1	0
1-T1S	38	38	38	38	38	37	37	37	37	37	37	36	36	36	36	36	36	35	35	35	35
2-T1S	37	37	37	37	37	36	36	36	36	36	36	35	35	35	35	35	35	34	34	34	34
3-T1S	36	36	36	35	35	35	35	35	35	34	34	34	34	34	34	33	33	33	33	33	33
4-T1S	35	35	35	34	34	34	34	34	34	33	33	33	33	33	33	32	32	32	32	32	32
5-T1S	34	34	34	33	33	33	33	33	33	32	32	32	32	32	31	31	31	31	31	31	31
6-T1S	32	32	32	32	31	31	31	31	31	31	31	31	30	30	30	30	30	30	30	30	29
7-T1S	31	31	31	31	30	30	30	30	30	30	30	30	29	29	29	29	29	29	29	29	28
8-T1S	29	29	29	29	28	28	28	28	28	28	28	28	27	27	27	27	27	27	27	27	26
T4	1	2	3	4	5	6	7	8	9	10	11	12	13	14	15	16	17	18	19	≥20	
1-T1S	35	35	34	34	34	34	34	34	33	33	33	33	33	33	32	32	32	32	32	32	32
2-T1S	34	34	33	33	33	33	33	33	32	32	32	32	32	32	31	31	31	31	31	31	31
3-T1S	32	32	32	32	32	32	31	31	31	31	31	31	30	30	30	30	30	30	29	29	29
4-T1S	31	31	31	31	31	31	30	30	30	30	30	30	29	29	29	29	29	29	28	28	28
5-T1S	30	30	30	30	30	30	29	29	29	29	29	29	28	28	28	28	28	28	27	27	27
6-T1S	29	29	29	29	29	29	28	28	28	28	28	27	27	27	27	27	27	27	26	26	26
7-T1S	28	28	28	28	28	28	27	27	27	27	27	26	26	26	26	26	26	26	25	25	25
8-T1S	26	26	26	26	26	26	26	25	25	25	25	25	25	25	25	24	24	24	24	24	24

2.The environment temperature curves of the high temperature setting for heating mode and ECO heating mode

T4	≤-20	-19	-18	-17	-16	-15	-14	-13	-12	-11	-10	-9	-8	-7	-6	-5	-4	-3	-2	-1	0
1-T1S	55	55	55	55	54	54	54	54	54	54	54	54	53	53	53	53	53	53	53	53	52
2-T1S	53	53	53	53	52	52	52	52	52	52	52	52	51	51	51	51	51	51	51	51	50
3-T1S	52	52	52	52	51	51	51	51	51	51	51	51	50	50	50	50	50	50	50	50	49
4-T1S	50	50	50	50	49	49	49	49	49	49	49	49	48	48	48	48	48	48	48	48	47
5-T1S	48	48	48	48	47	47	47	47	47	47	47	47	46	46	46	46	46	46	46	46	45
6-T1S	45	45	45	45	44	44	44	44	44	44	44	44	43	43	43	43	43	43	43	43	42
7-T1S	43	43	43	43	42	42	42	42	42	42	42	42	41	41	41	41	41	41	41	41	40
8-T1S	40	40	40	40	39	39	39	39	39	39	39	39	38	38	38	38	38	38	38	38	37
T4	1	2	3	4	5	6	7	8	9	10	11	12	13	14	15	16	17	18	19	≥20	
1-T1S	52	52	52	52	52	52	51	51	51	51	51	51	51	51	51	50	50	50	50	50	50
2-T1S	50	50	50	50	50	50	49	49	49	49	49	49	49	49	49	48	48	48	48	48	48
3-T1S	49	49	49	49	49	49	48	48	48	48	48	48	48	48	48	47	47	47	47	47	47
4-T1S	47	47	47	47	47	47	47	46	46	46	46	46	46	46	46	46	45	45	45	45	45
5-T1S	45	45	45	45	45	45	44	44	44	44	44	44	44	44	44	43	43	43	43	43	43
6-T1S	42	42	42	42	42	42	41	41	41	41	41	41	41	41	41	40	40	40	40	40	40
7-T1S	40	40	40	40	40	40	39	39	39	39	39	39	39	39	39	38	38	38	38	38	38
8-T1S	37	37	37	37	37	37	37	36	36	36	36	36	36	36	36	35	35	35	35	35	35

### 3.The automatic setting curve for heating mode

The automatic setting curve is the ninth curve,the ninth curve can be set as following:

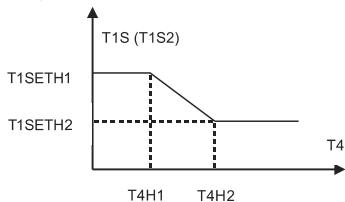

State:In the setting the wired controller, if  $T4H2 < T4H1$ , then exchange their value; if  $T1SETH1 < T1SETH2$ , then exchange their value.

### 4.The environment temperature curves of the low temperature setting for cooling mode

T4	$-10 \leq T4 < 15$	$15 \leq T4 < 22$	$22 \leq T4 < 30$	$30 \leq T4$
1-T1S	16	11	8	5
2-T1S	17	12	9	6
3-T1S	18	13	10	7
4-T1S	19	14	11	8
5-T1S	20	15	12	9
6-T1S	21	16	13	10
7-T1S	22	17	14	11
8-T1S	23	18	15	12

### 5.The environment temperature curves of the high temperature setting for cooling mode

T4	$-10 \leq T4 < 15$	$15 \leq T4 < 22$	$22 \leq T4 < 30$	$30 \leq T4$
1-T1S	20	18	17	16
2-T1S	21	19	18	17
3-T1S	22	20	19	17
4-T1S	23	21	19	18
5-T1S	24	21	20	18
6-T1S	24	22	20	19
7-T1S	25	22	21	19
8-T1S	25	23	21	20

### 6.The automatic setting curve for cooling mode

The automatic setting curve is the ninth curve,the ninth curve can be set as following:

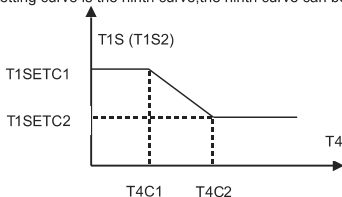

State:In the setting the wired controller, if  $T4C2 < T4C1$ , then exchange their value; if  $T1SETC1 < T1SETC2$ , then exchange their value.

## 10.2 DIP switch settings overview

### 10.2.1 Function setting

DIP switch is located on the hydraulic module main control board (see "9.3.1 main control board of hydraulic module") and allows configuration of additional heating source thermistor installation, the second inner backup heater installation, etc.

## ⚠ WARNING

- Switch off the power supply before opening the switch box service panel and making any changes to the DIP switch settings.
- Operate the switches with an insulated stick (such as a closed ball-point pen) to avoid electrostatic damage to the components.



DIP switch	ON=1	OFF=0	Factory defaults	DIP switch	ON=1	OFF=0	Factory defaults	DIP switch	ON=1	OFF=0	Factory defaults		
S1	1	Reserved	Reserved	Refer to electrically controlled wiring diagram	S2	1	Start pump after 24 hours will be invalid	Refer to electrically controlled wiring diagram	S4	1	Master unit: clear address of all slave units Slave unit: clear its own address	Keep the current address	
	2	Reserved	Reserved			2	Without TBH			With TBH	2	Reserved	Reserved
	3/4	0/0=Without IBH and AHS 1/0=With IBH 0/1=With AHS for heat mode 1/1=With AHS for heat mode and DHW mode				3/4	0/0=variable speed pump, Max head: 8,5m 0/1=constant speed pump 1/0=variable speed pump, Max head: 10,5m 1/1=variable speed pump, Max head: 9,0m				3/4	Reserved	

### 10.3 Initial start-up at low outdoor ambient temperature

During initial start-up and when water temperature is low, it is important that the water is heated gradually. Failure to do so may result in concrete floors cracking due to rapid temperature change. Please contact the responsible cast concrete building contractor for further details.

To do so, the lowest water flow set temperature can be decreased to a value between 25°C and 35°C by adjusting the FOR SERVICEMAN. Refer to "FOR SERVICEMAN/special function/preheating for floor" .

### 10.4 Pre-operation checks

Checks before initial start-up.

## ⚠ DANGER

Switch off the power supply before making any connections.

After the installation of the unit, check the following before switching on the circuit breaker:

- **Field wiring:** Make sure that the field wiring between the local supply panel and unit and valves (when applicable), unit and room thermostat (when applicable), unit and domestic hot water tank, and unit and backup heater kit have been connected according to the instructions described in the chapter 9.6 Field wiring, according to the wiring diagrams and to local laws and regulations.
- **Fuses, circuit breakers, or protection devices** Check that the fuses or the locally installed protection devices are of the size and type specified in the chapter 14 Technical specifications. Make sure that no fuses or protection devices have been bypassed.
- **Backup heater circuit breaker:** Do not forget to turn on the backup heater circuit breaker in the switchbox (it depends on the backup heater type). Refer to the wiring diagram.
- **Booster heater circuit breaker:** Do not forget to turn on the booster heater circuit breaker (applies only to units with optional domestic hot water tank installed).
- **Ground wiring:** Make sure that the ground wires have been connected properly and that the ground terminals are tightened.
- **Internal wiring:** Visually check the switch box for loose connections or damaged electrical components.
- **Mounting:** Check that the unit is properly mounted, to avoid abnormal noises and vibrations when starting up the unit.
- **Damaged equipment:** Check the inside of the unit for damaged components or squeezed pipes.
- **Refrigerant leak:** Check the inside of the unit for refrigerant leakage. If there is a refrigerant leak, call your local dealer.
- **Power supply voltage:** Check the power supply voltage on the local supply panel. The voltage must correspond to the voltage on the identification label of the unit.
- **Air purge valve:** Make sure the air purge valve is open (at least 2 turns).
- **Shut-off valves:** Make sure that the shut-off valves are fully open.

## 10.5 Powering up the unit

When power to the unit is turned on, "1%~99%" is displayed on the user interface during initialization. During this process the user interface cannot be operated.

## 10.6 Setting the pump speed

The pump speed can be selected by adjusting the red knob on the pump. The notch point indicates pump speed.

The default setting is the highest speed (III). If the water flow in the system is too high the speed can be set to low (I).

The available external static pressure function for water flow is shown in the graph below.

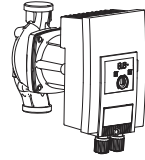

Available external static pressure VS Flow rate

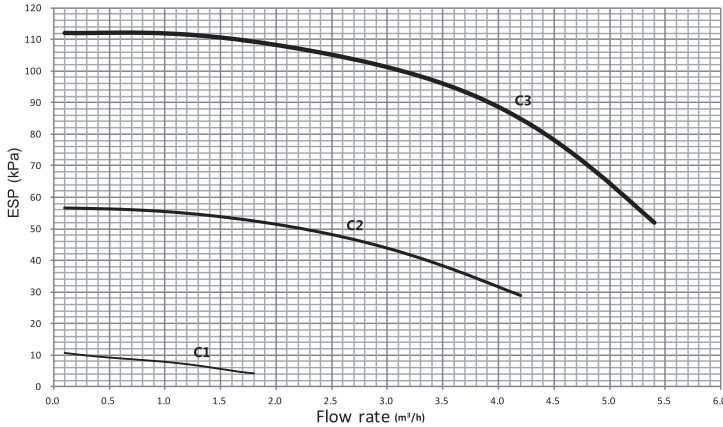

### ⚠ DANGER

- Operating the system with closed valves will damage the circulation pump!
- If it's necessary to check the running status of the pump when unit power on, please do not touch the internal electronic control box components to avoid electric shock.

## 1) Faults with external interference sources

Only have faults remedied by qualified personnel.

Faults	Causes	Remedy
Pump is not running although the power supply is switched on. Black display	Electrical fuse defective	Check fuses.
	Pump has no voltage.	Restore power after interruption.
Pump is making noises.	Cavitation due to insufficient suction pressure.	Increase the system suction pressure within the permissible range.
		Check the delivery head setting and set to lower head if necessary.

## 2) Fault signals

- The fault signal is indicated by the LED display .
- The fault signal LED is continuously illuminated in red .
- The pump switches off (depending on the error code), and attempts a cyclical restart.

### i INFORMATION

- EXCEPTION: Error code E10 (blocking)  
After approx. 10 minutes, the pump switches off permanently and displays the error code.



Code no.	Fault	Cause	Remedy
E04	Mains undervoltage	Power supply too low on mains side	Check mains voltage.
E05	Mains overvoltage	Power supply too high on mains side	Check mains voltage.
E09	Turbine operation	The pump is driven in reverse (the fluid flows through the pump from the pressure to the suction side)	Check flow, install non-return valves if necessary
E10	Blocking	The rotor is blocked	Request customer service
E21 *	Overload	Sluggish motor	Request customer service
E23	Short-circuit	Motor current too high	Request customer service
E25	Contacting/winding	Motor winding defective	Request customer service
E30	Module overheated	Module interior too warm	Improve room ventilation, check operating conditions, request customer service, if necessary
E31	Overheated power section	Ambient temperature too high	Improve room ventilation, check operating conditions, request customer service, if necessary
E36	Electronic faults	Electronics defective	Request customer service

\* In addition to the LED display, the fault signal LED is continuously illuminated in red.

## 2) Warning signals

- The warning signal is indicated by the LED display.
- The fault signal LED and the SSM relay do not respond.
- The pump continues to run with limited output.
- The indicated faulty operating status must not occur for a prolonged period. The cause must be eliminated.

Code no.	Fault	Cause	Remedy
E07	Generator operation	Pump hydraulics have fluid running through them.	Check the system
E11	Dry running	Air in the pump	Check the water volume/pressure
E21 *	Overload	Sluggish motor, pump is operated outside of its specifications (e.g. high module temperature). The speed is lower than during normal operation.	Check the ambient conditions

\* See also fault signal E21.

### NOTE

- If the operating fault cannot be remedied, please consult a specialist technician or the nearest customer service location or representative.
- In order to ensure the service life of the pump, it is recommended that the unit run at least once every 2 weeks (ensure that the pump is running) or keep it powered on for a long time (in the power-on standby state, the unit will run the pump for 1 minutes every 24 hours)

## 10.7 Field settings

The unit shall be configured by the installer to match the installation environment (outdoor climate, installed options, etc.) and user demand. A number of field settings are available. These settings are accessible and programmable through "FOR SERVICEMAN" in user interface.

### Powering on the unit

When power on the unit, "1%~99%" is displayed on the user interface during initialization. During this process the user interface cannot be operated.

### Procedure

To change one or more field settings, proceed as follows.

### NOTE

Temperature values displayed on the wired controller (user interface) are in °C.

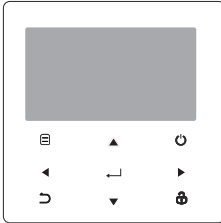

Keys	Function
	• Go to the menu structure(on the home page)
	• Navigate the cursor on the display • Navigate in the menu structure • Adjust settings
	• Turn on/off the space heating/cooling operation or DHW mode • Turn on/or off functions in the menu structure
	• Come back to the up level
	• Long press for unlock /lock the controller • Unlock /lock some functions such as "DHW temperature adjusting"
	• Go to the next step when programming a schedule in the menu structure; and confirm a selection to enter in the submenu of the menu structure.

### About FOR SERVICEMAN

"FOR SERVICEMAN" is designed for the installer to set the parameters.

- Setting the composition of equipment.
- Setting the parameters.

How to go to FOR SERVICEMAN

Go to > FOR SERVICEMAN. Press :

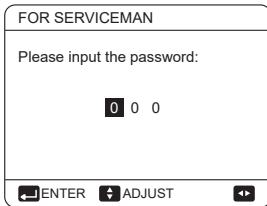

Press to navigate and press to adjust the numerical value. Press . The password is 234, the following pages will be displayed after putting the password:

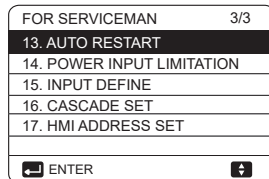
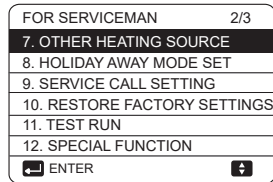
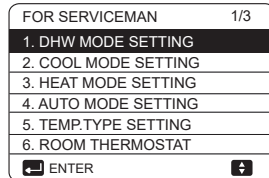

Press to scroll and use "" to enter submenu.

### 10.7.1 DHW MODE SETTING

DHW = domestic hot water

Go to > FOR SERVICEMAN> 1.DHW MODE SETTING. Press . The following pages will be displayed:

1 DHW MODE SETTING	1/5
1.1 DHW MODE	YES
1.2 DISINFECT	YES
1.3 DHW PRIORITY	YES
1.4 PUMP_D	YES
1.5 DHW PRIORITY TIME SET	NON
ADJUST	

1 DHW MODE SETTING	2/5
1.6 dT5_ON	5°C
1.7 dT1S5	10°C
1.8 T4DHWMAX	43°C
1.9 T4DHWMIN	-10°C
1.10 t_INTERVAL_DHW	5 MIN
ADJUST	

1 DHW MODE SETTING	3/5
1.11 dT5_TBH_OFF	5°C
1.12 T4_TBH_ON	5°C
1.13 t_TBH_DELAY	30 MIN
1.14 T5_DISINFECT	65°C
1.15 t_DI_HIGHTEMP.	15MIN
ADJUST	

1 DHW MODE SETTING	4/5
1.16 t_DI_MAX	240 MIN
1.17 t_DHWHP_RESTRICT	30 MIN
1.18 t_DHWHP_MAX	120 MIN
1.19 PUMP_D TIMER	YES
1.20 PUMP_D RUNNING TIME	5 MIN
ADJUST	

1 DHW MODE SETTING	5/5
1.21 PUMP_D DISINFECT RUN	NON
ADJUST	

### 10.7.2 COOL MODE SETTING

Go to > FOR SERVICEMAN> 2.COOL MODE SETTING. Press .

The following pages will be displayed:

2 COOL MODE SETTING	1/3
2.1 COOL MODE	YES
2.2 t_T4_FRESH_C	2.0HRS
2.3 T4CMAX	43°C
2.4 T4CMIN	20°C
2.5 dT1SC	5°C
ADJUST	

2 COOL MODE SETTING	2/3
2.6 dTSC	2°C
2.7 t_INTERVAL_C	5MIN
2.8 T1SetC1	10°C
2.9 T1SetC2	16°C
2.10 T4C1	35°C
ADJUST	

2 COOL MODE SETTING	3/3
2.11 T4C2	25°C
2.12 ZONE1 C-EMISSION	FCU
2.13 ZONE2 C-EMISSION	FLH
ADJUST	

### 10.7.3 HEAT MODE SETTING

Go to >FOR SERVICEMAN> 3.HEAT MODE SETTING. Press . The following pages will be displayed:

3 HEAT MODE SETTING	1/3
3.1 HEAT MODE	YES
3.2 t_T4_FRESH_H	2.0HRS
3.3 T4HMAX	16°C
3.4 T4HMIN	-15°C
3.5 dT1SH	5°C
ADJUST	

3 HEAT MODE SETTING	2/3
3.6 dTSH	2°C
3.7 t_INTERVAL_H	5MIN
3.8 T1SetH1	35°C
3.9 T1SetH2	28°C
3.10 T4H1	-5°C
ADJUST	

3 HEAT MODE SETTING	3/3
3.11 T4H2	7°C
3.12 ZONE1 H-EMISSION	RAD.
3.13 ZONE2 H-EMISSION	FLH
3.14 t_DELAY_PUMP	2MIN
ADJUST	

### 10.7.4 AUTO MODE SETTING

Go to > FOR SERVICEMAN> 4.AUTO MODE SETTING. Press , the following page will be displayed.

4 AUTO. MODE SETTING	
4.1 T4AUTOCMIN	25°C
4.2 T4AUTOHMAX	17°C
ADJUST	

### 10.7.5 TEMP. TYPE SETTING

#### About TEMP. TYPE SETTING

The TEMP. TYPE SETTING is used for selecting whether the water flow temperature or room temperature is used to control the ON/OFF of the heat pump.



When ROOM TEMP. is enabled, the target water flow temperature will be calculated from climate-related curves.

How to enter the TEMP. TYPE SETTING



Go to > FOR SERVICEMAN> 5.TEMP. TYPE SETTING. Press . The following page will be displayed:

5 TEMP. TYPE SETTING	
5.1 WATER FLOW TEMP.	YES
5.2 ROOM TEMP.	NON
5.3 DOUBLE ZONE	NON
ADJUST	

If you only set WATER FLOW TEMP. to YES, or only set ROOM TEMP. to YES, The following pages will be displayed.







01-01-2018	23:59	↑13°
	ON	
△ 23 °C		38 °C

only WATER FLOW TEMP. YES

01-01-2018	23:59	↑13°
	ON	
23.5 °C		38

only ROOM TEMP. YES

If you set WATER FLOW TEMP. and ROOM TEMP. to YES, meanwhile set DOUBLE ZONE to NON or YES, the following pages will be displayed.







01-01-2018	23:59	↑13°	01-01-2018	23:59	↑13°
	ON			ON	
△ 23 °C		38 °C	23.5 °C		

Homepage (zone 1)

Addition page (zone 2)(Double zone is effective)

In this case, the setting value of zone 1 is T1S, the setting value of zone 2 is TS (The corresponding T1S2 is calculated according to the climate related curves.)

If you set DOUBLE ZONE to YES and set ROOM TEMP. to NON, meanwhile set WATER FLOW TEMP. to YES or NON, the following pages will be displayed.







01-01-2018	23:59	↑13°	01-01-2018	23:59	↑13°
	ON			ON	
△ 23 °C		38 °C	△ 23 °C		

Homepage (zone 1)

Addition page (zone 2)

In this case, the setting value of zone 1 is T1S, the setting value of zone 2 is T1S2.

If you set DOUBLE ZONE and ROOM TEMP. to YES, meanwhile set WATER FLOW TEMP. to YES or NON, the following page will be displayed.

01-01-2018	23:59	↑13°	01-01-2018	23:59	↑13°
	ON			ON	
△ 23 °C		38 °C	23.5 °C		

Homepage (zone 1)

Addition page (zone 2)(Double zone is effective)



In this case, the setting value of zone 1 is T1S, the setting value of zone 1 is TS (The corresponding T1S2 is calculated according to the climate related curves.)

## 10.7.6 ROOM THERMOSTAT

### About ROOM THERMOSTAT

The ROOM THERMOSTAT is used to set whether the room thermostat is available.

#### How to set the ROOM THERMOSTAT

Go to  >FOR SERVICEMAN> 6.ROOM THERMOSTAT. Press . The following page will be displayed:

6 ROOM THERMOSTAT	
6.1 ROOM THERMOSTAT	NON
 ADJUST	

**NOTE**

ROOM THERMOSTAT = NON, no room thermostat.

ROOM THERMOSTAT = MODE SET, the wiring of room thermostat should follow method A.

ROOM THERMOSTAT=ONE ZONE, the wiring of room thermostat should follow method B.

ROOM THERMOSTAT=DOUBLE ZONE, the wiring of room thermostat should follow method C (refer to **9.7.6 "Connection for other components/For room thermostat"**)

**10.7.7 Other HEATING SOURCE**

The OTHER HEATING SOURCE is used to set the parameters of the backup heater, additional heating sources and solar energy kit.

Go to **☰ > FOR SERVICEMAN> 7.OTHER HEATING SOURCE**, Press **↔**. The following page will be displayed:

7 OTHER HEATING SOURCE 1/2	
7.1 dt1_IBH_ON	5°C
7.2 t_IBH_DELAY	30MIN
7.3 T4_IBH_ON	-5°C
7.4 dt1_AHS_ON	5°C
7.5 t_AHS_DELAY	30MIN
← ADJUST →	

7 OTHER HEATING SOURCE 2/2	
7.6 T4_AHS_ON	5°C
7.7 IBH LOCATE	PIPE LOOP
7.8 P_IBH1	0.0kW
7.9 P_IBH2	0.0kW
7.10 P_TBH	2.0kW
← ADJUST →	

**10.7.8 HOLIDAY AWAY SETTING**

The HOLIDAY AWAY SETTING is used to set the outlet water temperature to prevent freezing when away for holiday.

Go to **☰ > FOR SERVICEMAN> 8.HOLIDAY AWAY SETTING**. Press **↔**. The following page will be displayed:

8 HOLIDAY AWAY SETTING	
8.1 T1S_H.A. H	20°C
8.2 T5S_H.A. DHW	20°C
← ADJUST →	

**10.7.9 SERVICE CALL SETTING**

The installers can set the phone number of the local dealer in SERVICE CALL SETTING. If the unit doesn't work properly, call this number for help.

Go to **☰ > FOR SERVICEMAN>SERVICE CALL**. Press **↔**. The following page will be displayed:

9 SERVICE CALL SETTING	
PHONE NO. *****	
MOBILE NO. *****	
← CONFIRM → ADJUST →	

Press **▼ ▲** to scroll and set the phone number. The maximum length of the phone number is 13 digits, if the length of phone number is short than 12, please input **■**, as shown below:

9 SERVICE CALL	
PHONE NO. ***** ■■	
MOBILE NO. ***** ■	
← CONFIRM → ADJUST →	

The number displayed on the user interface is the phone number of your local dealer.

**10.7.10 RESTORE FACTORY SETTINGS**

The RESTORE FACTORY SETTING is used to restore all the parameters set in the user interface to the factory setting.

Go to **☰ > FOR SERVICEMAN > 10.RESTORE FACTORY SETTINGS**. Press **↔**. The following page will be displayed:

10 RESTORE FACTORY SETTINGS	
All the settings will come back to factory default. Do you want to restore factory settings?	
NO YES	
← CONFIRM →	

Press **◀ ▶** to scroll the cursor to YES and press **↔**. The following page will be displayed:

10 RESTORE FACTORY SETTINGS	
Please wait...	
5%	

After a few seconds, all the parameters set in the user interface will be restored to factory settings.

**10.7.11 TEST RUN**

TEST RUN is used to check correct operation of the valves, air purge, circulation pump operation, cooling, heating and domestic water heating.

Go to > FOR SERVICEMAN> 11.TEST RUN.  
Press . The following page will be displayed:

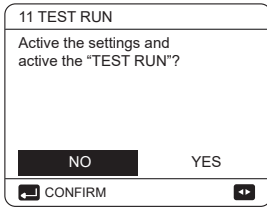

If YES is selected, the following pages will be displayed:

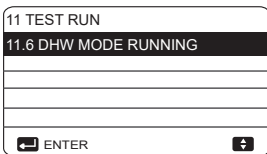
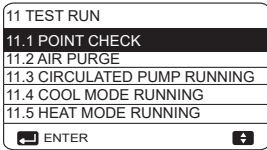

If POINT CHECK is selected, the following pages will be displayed:

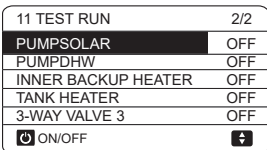
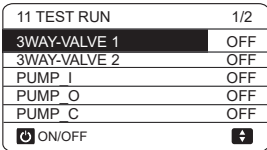

Press to scroll to the components you want to check and press . For example, when 3-way valve is selected and is pressed, if the 3-way valve is open/close, then the operation of 3-way valve is normal, and so are other components.

### CAUTION

Before the point check, make sure the tank and the water system is filled with water, and air is expelled, or it may cause the pump or backup heater burn out.

If you select AIR PURGE and is pressed, the following page will be displayed :

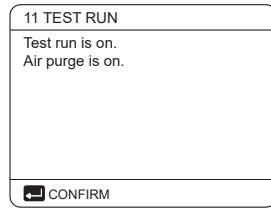

When in air purge mode, SV1 will open, SV2 will close. 60s later the pump in the unit (PUMPI) will operate for 10min during which the flow switch will not work. After the pump stops, the SV1 will close and the SV2 will open. 60s later both the PUMPI and PUMPO will operate until the next command is received.

When CIRCULATION PUMP RUNNING is selected, the following page will be displayed:

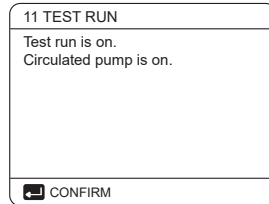

When circulation pump running is turned on, all running components will stop. 60 seconds later, the SV1 will open, the SV2 will close, 60 seconds later PUMPI will operate. 30s later, if the flow switch checked normal flow, PUMPI will operate for 3min, after the pump stops 60 seconds, the SV1 will close and the SV2 will open. 60s later the both PUMPI and PUMPO will operate, 2 mins later, the flow switch will check the water flow. If the flow switch closes for 15s, PUMPI and PUMPO will operate until the next command is received.

When the COOL MODE RUNNING is selected, the following page will be displayed:

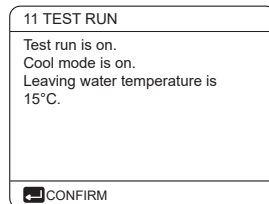

During COOL MODE test running, the default target outlet water temperature is 7°C. The unit will operate until the water temperature drops to a certain value or the next command is received.

When the HEAT MODE RUNNING is selected, the following page will be displayed:

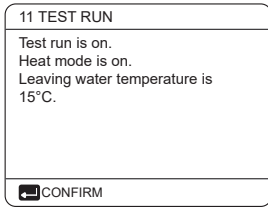

During HEAT MODE test running, the default target outlet water temperature is 35°C. The IBH (internal backup heater) will turn on after the compressor runs for 10 min. After the IBH runs for 3 minutes, the IBH will turn off, the heat pump will operate until the water temperature increase to a certain value or the next command is received.

When the DHW MODE RUNNING is selected, the following page will be displayed:

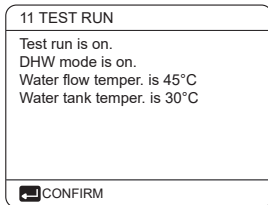

During DHW MODE test running, the default target temperature of the domestic water is 55°C. The TBH (tank boost heater) will turn on after the compressor runs for 10min. The TBH will turn off 3 minutes later, the heat pump will operate until the water temperature increase to a certain value or the next command is received.

During test run, all buttons except **↵** are invalid. If you want to turn off the test run, please press **↵**. For example, when the unit is in air purge mode, after you press **↵**, the following page will be displayed:

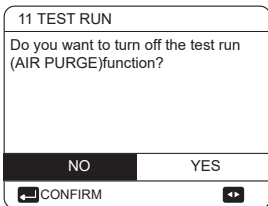

Press **◀ ▶** to scroll the cursor to YES and press **↵**. The test run will turn off.

### 10.5.12 SPECIAL FUNCTION

When it is in special function modes, the wired controller can not operate, the page do not return to the homepage, and the screen showed the page that special function runs, the wired controller do not locked.

#### NOTE

During special function operating other functions (WEEKLY SCHEDULE/TIMER, HOLIDAY AWAY, HOLIDAY HOME) can't be used.

Go to **☰ > FOR SERVICEMAN > 12.SPECIAL FUNCTION.**

Before floor heating, if a large amount of water remains on the floor, the floor may be warped or even rupture during floor heating operation, in order to protect the floor, floor drying is necessary, during which the temperature of the floor should be increased gradually.

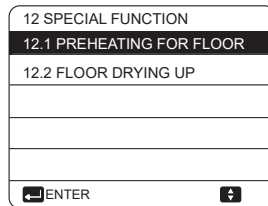
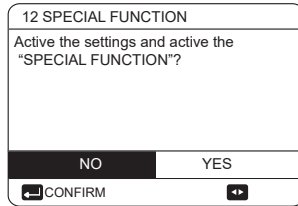

Press **▲ ▼** to scroll and press **↵** to enter.

During first operation of the unit, air may remain in the water system which can cause malfunctions during operation. It is necessary to run the air purge function to release the air (make sure the air purge valve is open).

If PREHEATING FOR FLOOR is selected, after press **↵**, the following page will be displayed:

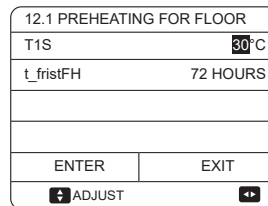

When the cursor is on OPERATE PREHEATING FOR FLOOR, Use **◀ ▶** to scroll to YES and press **↵**. The following page will be displayed:

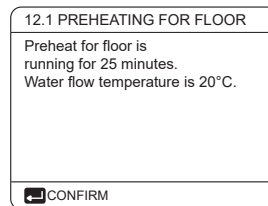

During preheating for floor, all the buttons except  $\rightarrow$  are invalid. If you want to turn off the preheating for floor, please press  $\rightarrow$ .

The following page will be displayed:

12.1 PREHEATING FOR FLOOR	
Do you want to turn off the preheating for floor function?	
NO	YES
$\leftarrow$ CONFIRM	$\rightarrow$

Use  $\leftarrow$   $\rightarrow$  to scroll the cursor to YES and press  $\rightarrow$ , the preheating for floor will turn off.

The operation of the unit during preheating for floor described in the picture below:

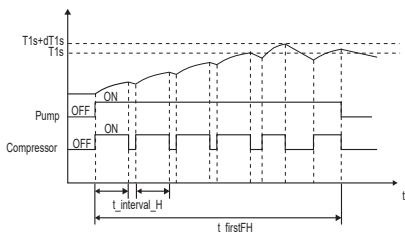

If FLOOR DRYING UP is selected, after pressing  $\rightarrow$ , the following pages will be displayed:

12.2 FLOOR DRYING UP	
t_DRYUP	8 days
t_HIGHPEAK	5 days
t_DRYDOWN	5 days
T_DRYPEAK	45°C
START TIME	15:00
$\leftarrow$ ADJUST	$\rightarrow$

12.2 FLOOR DRYING UP	
START DAY	01-01-2019
ENTER	EXIT
$\leftarrow$ ADJUST	$\rightarrow$

When the cursor is on OPERATE FLOOR DRYING, use  $\leftarrow$   $\rightarrow$  to scroll to YES and press  $\rightarrow$ . The following page will be displayed:

12.2 FLOOR DRYING UP	
DO YOU WANT TO TURN OFF THE FLOOR DRYING UP FUNCTION?	
NO	YES
$\leftarrow$ CONFIRM	$\rightarrow$

During floor drying, all the buttons except  $\rightarrow$  are invalid. When the heat pump malfunctions, the floor drying mode will turn off when the backup heater and additional heating source is unavailable. If you want to turn off floor drying up, please press  $\rightarrow$ . The following page will be displayed:

12.3 FLOOR DRYING UP	
THE UNIT WILL OPERATE FLOOR DRYING UP ON 09:00 01-08-2018.	
$\leftarrow$ CONFIRM	

Use  $\leftarrow$   $\rightarrow$  to scroll the cursor to YES and press  $\rightarrow$ . Floor drying will turn off.

The target outlet water temperature during floor drying up described in the picture below:

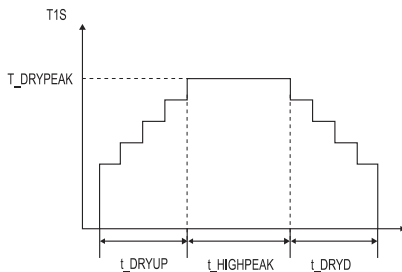

### 10.7.13 AUTO RESTART

The AUTO RESTART function is used to select whether the unit reapplies the user interface settings at the time when power returns after a power supply failure.

Go to  $\text{Menu} > \text{FOR SERVICEMAN} > 13. \text{AUTO RESTART}$

13 AUTO RESTART	
13.1 COOL/HEAT MODE	YES
13.2 DHW MODE	NON
$\leftarrow$ ADJUST	$\rightarrow$





## 10.7.16 Setting parameters

The parameters related to this chapter are shown in the table below.

Order number	Code	State	Default	Minumum	Maximum	Setting interval	Unit
1.1	DHW MODE	Enable or disable the DHW mode:0=NON,1=YES	1	0	1	1	/
1.2	DISINFECT	Enable or disable the disinfect mode:0=NON,1=YES	1	0	1	1	/
1.3	DHW PRIORITY	Enable or disable the DHW priority mode:0=NON,1=YES	1	0	1	1	/
1.4	PUMP_D	Enable or disable the DHW pump mode:0=NON,1=YES	0	0	1	1	/
1.5	DHW PRIORITY TIME SET	Enable or disable the DHW priority time set:0=NON,1=YES	0	0	1	1	/
1.6	dT5_ON	The temperature difference for starting the heat pump	10	1	30	1	°C
1.7	dT1S5	The difference value between Twout and T5 in DHW mode	10	5	40	1	°C
1.8	T4DHWMAX	The maximum ambient temperature that the heat pump can operate at for domestic water heating	43	35	43	1	°C
1.9	T4DHWMIN	The minimum ambient temperature that the heat pump can operate for domestic water heating	-10	-25	30	1	°C
1.10	t_INTERVAL_DHW	the start time interval of the compressor in DHW mode.	5	5	5	1	MIN
1.11	dT5_TBH_OFF	the temperature difference between T5 and T5S that turns the booster heater off.	5	0	10	1	°C
1.12	T4_TBH_ON	the highest outdoor temperature the TBH can operate.	5	-5	50	1	°C
1.13	t_TBH_DELAY	the time that the compressor has run before starting the booster heater	30	0	240	5	MIN
1.14	T5S_DISINFECT	the target temperature of water in the domestic hot water tank in the DISINFECT function.	65	60	70	1	°C
1.15	t_DI_HIGHTEMP.	the time that the highest temperature of water in the domestic hot water tank in the DISINFECT function will last	15	5	60	5	MIN
1.16	t_DI_MAX	the maximum time that disinfection will last	210	90	300	5	MIN
1.17	t_DHWHP_RESTRICT	he operation time for the space heating/cooling operation.	30	10	600	5	MIN
1.18	t_DHWHP_MAX	the maximum continuous working period of the heat pump in DHW PRIORITY mode.	90	10	600	5	MIN
1.19	PUMP_D TIMER	Enable or disable the DHW pump run as timed and keeps running for PUMP RUNNING TIME:0=NON,1=YES	1	0	1	1	/
1.20	PUMP_D RUNNING TIME	the certain time that the DHW pump will keep running for	5	5	120	1	MIN
1.21	PUMP_D DISINFECT RUN	Enable or disable the DHW pump operate when the unit is in disinfect mode and T5: T5S_Dk:2:0=NON,1=YES	1	0	1	1	/
2.1	COOL MODE	Enable or disable the cooling mode:0=NON,1=YES	1	0	1	1	/
2.2	t_T4_FRESH_C	The refresh time of climate related curves for cooling mode	0.5	0.5	6	0.5	hours
2.3	T4CMAX	The highest ambient operation temperature for cooling mode	52	35	52	1	°C
2.4	T4CMIN	the lowest ambient operating temperature for cooling mode	10	-5	25	1	°C
2.5	dT1SC	the temperature difference for starting the heat pump(T1)	5	2	10	1	°C
2.6	dTSC	the temperature difference for starting the heat pump(Ta)	2	1	10	1	°C
2.7	t_INTERVAL_COOL	the start time interval of the compressor in COOL mode	5	5	5	1	°C
2.8	T1SetC1	The setting temperature 1 of climate related curves for cooling mode.	10	5	25	1	MIN
2.9	T1SetC2	The setting temperature 2 of climate related curves for cooling mode.	16	5	25	1	°C
2.10	T4C1	The ambient temperature 1 of climate related curves for cooling mode.	35	-5	46	1	°C
2.11	T4C2	The ambient temperature 2 of climate related curves for cooling mode.	25	-5	46	1	°C
2.12	ZONE1 C-EMISSION	The type of zone1 end for cooling mode 0=FCU(fan coil unit), 1=RAD.(radiator), 2=FLH(floor heating)	0	0	2	1	/
2.13	ZONE2 C-EMISSION	The type of zone2 end for cooling mode 0=FCU(fan coil unit), 1=RAD.(radiator), 2=FLH(floor heating)	0	0	2	1	/

3.1	HEAT MODE	Enable or disable the heating mode	1	0	1	1	/
3.2	t_T4_FRESH_H	The refresh time of climate related curves for heating mode	0.5	0.5	6	0.5	hours
3.3	T4HMAX	The maximum ambient operating temperature for heating mode	25	20	35	1	°C
3.4	T4HMIN	The minimum ambient operating temperature for heating mode	-15	-25	30	1	°C
3.5	dT1SH	The temperature difference for starting the unit (T1)	5	2	20	1	°C
3.6	dTSH	The temperature difference for starting the unit (Ta)	2	1	10	1	°C
3.7	t_INTERVAL_HEAT	the start time interval of the compressor in HEAT mode	5	5	5	1	MIN
3.8	T1SetH1	The setting temperature 1 of climate related curves for heating mode	35	25	65	1	°C
3.9	T1SetH2	The setting temperature 2 of climate related curves for heating mode	28	25	65	1	°C
3.10	T4H1	The ambient temperature 1 of climate related curves for heating mode	-5	-25	35	1	°C
3.11	T4H2	The ambient temperature 2 of climate related curves for heating mode	7	-25	35	1	°C
3.12	ZONE1 H-EMISSION	The type of zone1 end for heating mode : 0=FCU(fan coil unit) , 1=RAD.(radiator) , 2=FLH(floor heating)	1	0	2	1	/
3.13	ZONE2 H-EMISSION	The type of zone2 end for heating mode : 0=FCU(fan coil unit) , 1=RAD.(radiator) , 2=FLH(floor heating)	2	0	2	1	/
3.14	t_DELAY_PUMP	The delay time for water pump to stop after the compressor stops	2	0.5	20	0.5	MIN
4.1	T4AUTOCMIN	The minimum operating ambient temperature for cooling in auto mode	25	20	29	1	°C
4.2	T4AUTOHMAX	The maximum operating ambient temperature for heating in auto mode	17	10	17	1	°C
5.1	WATER FLOW TEMP.	Enable or disable the WATER FLOW TEMP.:0=NON,1=YES	1	0	1	1	/
5.2	ROOM TEMP.	Enable or disable the ROOM TEMP.:0=NON,1=YES	0	0	1	1	/
5.3	DOUBLE ZONE	Enable or disable the ROOM THERMOSTAT DOUBLE ZONE:0=NON,1=YES	0	0	1	1	/
6.1	ROOM THERMOSTAT	The style of room thermostat 0=NON,1=MODE SET,2=ONE ZONE,3=DOUBLE ZONE	0	0	3	1	/
7.1	dT1_IBH_ON	The temperature difference between T1S and T1 for starting the backup heater.	5	2	10	1	°C
7.2	t_IBH_DELAY	The time that the compressor has run before the first backup heater turns on	30	15	120	5	MIN
7.3	T4_IBH_ON	The ambient temperature for starting the backup heater	-5	-15	30	1	°C
7.4	dT1_AHS_ON	The temperature difference between T1S and T1 for turning the additional heating source on	5	2	20	1	°C
7.5	t_AHS_DELAY	The time that the compressor has run before starting the additional heating source	30	5	120	5	MIN
7.6	T4_AHS_ON	The ambient temperature for starting the additional heating source	-5	-15	30	1	°C
7.7	IBH_LOCATE	IBH/AHS installation location PIPE LOOP=0; BUFFER TANK=1	0	0	0	0	°C
7.8	P_IBH1	Power input of IBH1	0	0	20	0.5	kW
7.9	P_IBH2	Power input of IBH2	0	0	20	0.5	kW
7.10	P_TBH	Power input of TBH	2	0	20	0.5	kW
8.1	T1S_HA_H	The target outlet water temperature for space heating when in holiday away mode	25	20	25	1	°C
8.2	T5S_HA_DHW	The target outlet water temperature for domestic hot water heating when in holiday away mode	25	20	25	1	°C
12.1	PREHEATING FOR FLOOR T1S	The setting temperature of outlet water during first preheating for floor	25	25	35	1	°C
12.3	t_FIRSTFH	The time last for preheating floor	72	48	96	12	HOURL

12.4	t_DRYUP	The day for warming up during floor drying up	8	4	15	1	DAY
12.5	t_HIGHPEAK	The continue days in high temperature during floor drying up	5	3	7	1	DAY
12.6	t_DRYD	The day of dropping temperature during floor drying up	5	4	15	1	DAY
12.7	T_DRYPEAK	The target peak temperature of water flow during floor drying up	45	30	55	1	°C
12.8	START TIME	The start time of floor drying up	Hour: the present time(not on the hour +1, on the hour +2) Mminute:00	0:00	23:30	1/30	h/min
12.9	START DATE	The start date of floor drying up	The present date	1/1/2000	31/12/2099	1/1/2001	d/m/y
13.1	AUTO RESTART COOL/HEAT MODE	Enable or disable the auto restart cooling/heating mode. 0=NON,1=YES	1	0	1	1	/
13.2	AUTO RESTART DHW MODE	Enable or disable the auto restart DHW mode. 0=NON,1=YES	1	0	1	1	/
14.1	POWER INPUT LIMITATION	The type of power input limitation, 0=NON, 1~8=TYPE 1~8	0	0	8	1	/
15.1	M1 M2	Define the function of the M1M2 switch; 0= REMOTE ON/OFF,1= TBH ON/OFF,2= AHS ON/OFF	0	0	2	1	/
15.2	SMART GRID	Enable or disable the SMART GRID; 0=NON,1=YES	0	0	1	1	/
15.3	Tw 2	Enable or disable the T1b(Tw 2) ; 0=NON,1=YES	0	0	1	1	/
15.4	Tbt1	Enable or disable the Tbt1; 0=NON,1=YES	0	0	1	1	/
15.5	Tbt2	Enable or disable the Tbt2; 0=NON,1=YES	0	0	1	1	/
15.6	Ta	Enable or disable the Ta; 0=NON,1=YES	0	0	1	1	/
15.7	Ta-adj	The corrected value of Ta on wired controller	-2	-10	10	1	°C
15.8	SOLAR INPUT	Choose the SOLAR INPUT; 0=NON,1=CN18Tsolar,2=CN11SL1SL2	0	0	2	1	/
15.9	F-PIPE LENGTH	Choose the total length of the liquid pipe(F-PIPE LENGTH); 0=F-PIPE LENGTH< 10m,1=F-PIPE LENGTH≥ 10m	0	0	1	1	/
15.10	RT/Ta_FCB	Enable or disable the RT/Ta_FCB; 0=NON,1=YES	0	0	1	1	/
15.11	PUMP_I SILENT MODE	Enable or disable PUMPI SILENT MODE 0=NON, 1=YES	0	0	1	1	/
15.12	DFT1/DFT2	DFT1/DFT2 port function:0=DEFROST 1=ALARM	0	0	1	1	/
16.1	PER_START	Start-up percentage of multiple units	10	10	100	10	%
16.2	TIME_ADJUST	Adjustment time of adding and subtracting units	5	1	60	1	MIN
16.3	ADDRESS RESET	Reset the address code of the unit	FF	0	15	1	/
17.1	HMI SET	Choose the HMI; 0=MASTER,1=SLAVE	0	0	1	1	/
17.2	HMI ADDRESS FOR BMS	Set the HMI address code for BMS	1	1	16	1	/
17.3	STOP BIT	HMI stop bit	1	1	2	1	/

### NOTE

15.12 DFT1/DFT2 ALARM function can be valid only with IDU software version higher than V99.

## 11 TEST RUN AND FINAL CHECKS

The installer is obliged to verify correct operation of unit after installation.

### 11.1 Final checks

Before switching on the unit, read following recommendations:

- When the complete installation and all necessary settings have been carried out, close all front panels of the unit and refit the unit cover.
- The service panel of the switch box may only be opened by a licensed electrician for

#### NOTE

That during the first running period of the unit, required power input may be higher than stated on the nameplate of the unit. This phenomenon originates from the compressor that needs elapse of a 50 hours run in period before reaching smooth operation and stable power consumption.

### 11.2 Test run operation (manually)

If required, the installer can perform a manual test run operation at any time to check correct operation of air purge, heating, cooling and domestic water heating, refer to 10.7 Field settings/test run.

## 12 MAINTENANCE AND SERVICE

In order to ensure optimal availability of the unit, a number of checks and inspections on the unit and the field wiring have to be carried out at regular intervals.

This maintenance needs to be carried out by your local technician.

In order to ensure optimal availability of the unit, a number of checks and inspections on the unit and the field wiring have to be carried out at regular intervals.

This maintenance has to be carried out by your local technician.

#### DANGER

##### ELECTRIC SHOCK

- Before carrying out any maintenance or repairing activity, must switch off the power supply on the supply panel.
- Do not touch any live part for 10 minutes after the power supply is turned off.
- The crank heater of compressor may operate even in standby.
- Please note that some sections of the electric component box are hot.
- Forbid touch any conductive parts.
- Forbid rinse the unit. It may cause electric shock or fire.
- Forbid leave the unit unattended when service panel is removed.

The following checks must be performed at least once a year by qualified person.

- Water pressure  
Check the water pressure, if it is below 1 bar, fill water to the system.
- Water filter  
Clean the water filter.
- Water pressure relief valve  
Check for correct operation of the pressure relief valve by turning the black knob on the valve counter-clockwise:  
-If you do not hear a clacking sound, contact your local dealer.  
-In case the water keeps running out of the unit, close both the water inlet and outlet shut-off valves first and then contact your local dealer.
- Pressure relief valve hose  
Check that the pressure relief valve hose is positioned appropriately to drain the water.
- Backup heater vessel insulation cover  
Check that the backup heater insulation cover is fastened tightly around the backup heater vessel.
- Domestic hot water tank pressure relief valve (field supply)  
Applies only to installations with a domestic hot water tank. Check for correct operation of the pressure relief valve on the domestic hot water tank.
- Domestic hot water tank booster heater  
Applies only to installations with a domestic hot water tank. It is advisable to remove lime buildup on the booster heater to extend its life span, especially in regions with hard water. To do so, drain the domestic hot water tank, remove the booster heater from the domestic hot water tank and immerse in a bucket (or similar) with lime-removing product for 24 hours.
- Unit switch box  
-Carry out a thorough visual inspection of the switch box and look for obvious defects such as loose connections or defective wiring.  
-Check for correct operation of contactors with an ohm meter. All contacts of these contactors must be in open position.  
Use of glycol (Refer to 9.3 Water pipework Caution: "Use of glycol" ) Document the glycol concentration and the pH-value in the system at least once a year.  
-A PH-value below 8,0 indicates that a significant portion of the inhibitor has been depleted and that more inhibitor needs to be added.  
-When the PH-value is below 7,0 then oxidation of the glycol occurred, the system should be drained and flushed thoroughly before severe damage occurs.

Make sure that the disposal of the glycol solution is done in accordance with relevant local laws and regulations.

## 13 TROUBLE SHOOTING

This section provides useful information for diagnosing and correcting certain troubles which may occur in the unit.

This troubleshooting and related corrective actions may only be carried out by your local technician.

### 13.1 General guidelines

Before starting the troubleshooting procedure, carry out a thorough visual inspection of the unit and look for obvious defects such as loose connections or defective wiring.

#### WARNING

When carrying out an inspection on the switch box of the unit, always make sure that the main switch of the unit is switched off.

When a safety device was activated, stop the unit and find out why the safety device was activated before resetting it. Under no circumstances can safety devices be bridged or changed to a value other than the factory setting. If the cause of the problem cannot be found, call your local dealer.

If the pressure relief valve is not working correctly and is to be replaced, always reconnect the flexible hose attached to the pressure relief valve to avoid water dripping out of the unit!

#### NOTE

For problems related to the optional solar kit for domestic water heating, refer to the troubleshooting in the Installation & Owner's manual for that kit.

### 13.2 General symptoms

Symptom 1: The unit is turned on but the unit is not heating or cooling as expected

POSSIBLE CAUSES	CORRECTIVE ACTION
The temperature setting is not correct.	Check the controller set point, T4HMAX, T4HMIN in heat mode. T4CMAX, T4CMIN in cool mode, T4DHWMAX, T4DHWMIN in DHW mode.
The water flow is too low.	<ul style="list-style-type: none"> <li>• Check that all shut off valves of the water circuit are completely open.</li> <li>• Check if the water filter needs cleaning.</li> <li>• Make sure there is no air in the system (purge air).</li> <li>• Check on the manometer that there is sufficient water pressure. The water pressure must be &gt;1 bar (water is cold).</li> <li>• Make sure that the expansion vessel is not broken.</li> <li>• Check that the resistance in the water circuit is not too high for the pump.</li> </ul>
The water volume in the installation is too low.	Make sure that the water volume in the installation is above the minimum required value (refer to "9.3 water piping/ Checking the water volume and expansion vessel pre-pressure").

Symptom 2: The unit is turned on but the compressor is not starting (space heating or domestic water heating)

POSSIBLE CAUSES	CORRECTIVE ACTION
The unit must start up out of its operation range (the water temperature is too low).	<p>In case of low water temperature, the system utilizes the backup heater to reach the minimum water temperature first (12°C).</p> <ul style="list-style-type: none"> <li>• Check that the backup heater power supply is correct.</li> <li>• Check that the backup heater thermal fuse is closed.</li> <li>• Check that the backup heater thermal protector is not activated.</li> <li>• Check that the backup heater contactors are not broken.</li> </ul>

Symptom 3: Pump is making noise (cavitation)

POSSIBLE CAUSES	CORRECTIVE ACTION
There is air in the system.	Purge air.
Water pressure at pump inlet is too low.	<ul style="list-style-type: none"> <li>• Check on the manometer that there is sufficient water pressure. The water pressure must be &gt; 1 bar (water is cold).</li> <li>• Check that the manometer is not broken.</li> <li>• Check that the expansion vessel is not broken.</li> <li>• Check that the setting of the pre- pressure of the expansion vessel is correct (refer to "9.3 water piping/Checking the water volume and expansion vessel pre-pressure").</li> </ul>

Symptom 4: The water pressure relief valve opens

POSSIBLE CAUSES	CORRECTIVE ACTION
The expansion vessel is broken.	Replace the expansion vessel.
The filling water pressure in the installation is higher than 0,3MPa.	Make sure that the filling water pressure in the installation is about 0,15~0,20MPa (refer to "9.3 water piping/Checking the water volume and expansion vessel pre-pressure").

Symptom 5: The water pressure relief valve leaks

POSSIBLE CAUSES	CORRECTIVE ACTION
Dirt is blocking the water pressure relief valve outlet.	<p>Check for correct operation of the pressure relief valve by turning the red knob on the valve counter clockwise:</p> <ul style="list-style-type: none"> <li>• If you do not hear a clacking sound, contact your local dealer.</li> <li>• In case the water keeps running out of the unit, close both the water inlet and outlet shut-off valves first and then contact your local dealer.</li> </ul>

Symptom 6: Space heating capacity shortage at low outdoor temperatures

POSSIBLE CAUSES	CORRECTIVE ACTION
Backup heater operation is not activated.	Check that the "OTHER HEATING SOURCE/ BACKUP HEATER" is enabled, see "10.7 Field settings" Check whether or not the thermal protector of the backup heater has been activated (refer to "Controls parts for backup heater(IBH) "). Check if booster heater is running, the backup heater and booster heater can't operate simultaneously.
Too much heat pump capacity is used for heating domestic hot water (applies only to installations with a domestic hot water tank).	<p>Check that the "t_DHWHP_MAX" and "t_DHWHP_RESTRICT" are configured appropriately:</p> <ul style="list-style-type: none"> <li>• Make sure that the "DHW PRIORITY" in the user interface is disabled.</li> <li>• Enable the "T4_TBH_ON" in the user interface/FOR SERVICEMAN to activate the booster heater for domestic water heating.</li> </ul>

Symptom 7: Heat mode can't change to DHW mode immediately

POSSIBLE CAUSES	CORRECTIVE ACTION
Volume of tank is too small and the location of water temperature probe not high enough	<ul style="list-style-type: none"> <li>• Set "dT1S5" to 20°C, and set "t_DHWHP_RESTRICT" to minimum value.</li> <li>• Set dT1SH to 2°C.</li> <li>• Enable TBH, and TBH should be controlled by the outdoor unit.</li> <li>• If AHS(boiler) is available, turn boiler on first, if requirement for turn heat pump on is fulfilled, the heat pump will turn on.</li> <li>• If both TBH and AHS are not available, try to change the position of T5 probe(refer to 2 General information/Domestic hot water tank).</li> </ul>

Symptom 8: DHW mode can't change to Heat mode immediately

POSSIBLE CAUSES	CORRECTIVE ACTION
Heat exchanger for space heating not big enough	<ul style="list-style-type: none"> <li>Set "t_DHWHP_MAX" to minimum value, the suggested value is 60min.</li> <li>If circulating pump out of unit is not controlled by unit, try to connect it to the unit.</li> <li>Add 3-way valve at the inlet of fan coil to ensure enough water flow.</li> </ul>
Space heating load is small	Normal , no need for heating
Disinfect function is enabled but without TBH	<ul style="list-style-type: none"> <li>Disable disinfect function</li> <li>add TBH or AHS for DHW mode</li> </ul>
Manual turn on the FAST WATER function, after the hot water meets the requirements, the heat pump fails to switch to the air-conditioning mode in time when the air conditioner is in demand	Manual turn off the FAST WATER function
When the ambient temperature is low, the hot water is not enough and the AHS is not operated or operated late	<ul style="list-style-type: none"> <li>Set "T4DHWMIN", the suggested value is <math>\geq -5^{\circ}\text{C}</math></li> <li>Set "T4_TBH_ON", the suggested value is <math>\geq 5^{\circ}\text{C}</math></li> </ul>
DHW mode priority	If there is AHS or IBH connect to the unit, when the outdoor unit failed, the hydraulic module board must run DHW mode till the water temperature reach the setting temperature before change to heating mode.

Symptom 9: DHW mode heat pump stop work but setpoint not reached, space heating require heat but unit stay in DHW mode

POSSIBLE CAUSES	CORRECTIVE ACTION
Surface of coil in the tank not large enough	The same solution for Symptom 7
TBH or AHS not available	Heat pump will stay in DHW mode until "t_DHWHP_MAX" reached or setpoint is reached. Add TBH or AHS for DHW mode, TBH and AHS should be controlled by the unit.

### 13.3 Operation parameter

This menu is for installer or service engineer reviewing the operation parameters.

- At home page, go to "➔" >"OPERATION PARAMETER".
- Press "⊞". There are nine pages for the operating parameter as following. Press "▼", "▲" to scroll.
- Press"▶" and "◀" to check slave units' operation parameter in cascade system. The address code in the upper right corner will change from "#00" to "#01", "#02" etc. accordingly

OPERATION PARAMETER	#00
ONLINE UNITS NUMBER	1
OPERATE MODE	COOL
SV1 STATE	ON
SV2 STATE	OFF
SV3 STATE	OFF
PUMP_I	ON
⏪ ADDRESS	1/9 ⏩

OPERATION PARAMETER	#00
PUMP-O	OFF
PUMP-C	OFF
PUMP-S	OFF
PUMP-D	OFF
PIPE BACKUP HEATER	OFF
TANK BACKUP HEATER	ON
⏪ ADDRESS	2/9 ⏩

OPERATION PARAMETER	#00
GAS BOILER	OFF
T1 LEAVING WATER TEMP.	35°C
WATER FLOW	1.72m <sup>3</sup> /h
HEAT PUMP CAPACTIY	11.52kW
POWER CONSUM.	1000kWh
Ta ROOM TEMP	25°C
⏪ ADDRESS	3/9 ⏩

OPERATION PARAMETER	#00
T5 WATER TANK TEMP.	53°C
Tw2 CIRCUIT2 WATER TEMP.	35°C
TIS' C1 CLI. CURVE TEMP.	35°C
TIS2' C2 CLI. CURVE TEMP.	35°C
TW_O PLATE W-OUTLET TEMP.	35°C
TW_I PLATE W-OUTLET TEMP.	30°C
⏪ ADDRESS	4/9 ⏩

OPERATION PARAMETER	#00
Tbt1 BUFFERTANK_UP TEMP.	35°C
Tbt2 BUFFERTANK_LOW TEMP.	35°C
Tsolar	25°C
IDU SOFTWARE	01-09-2019V01
⏪ ADDRESS	5/9 ⏩

OPERATION PARAMETER	#00
ODU MODEL	6kW
COMP.CURRENT	12A
COMP.FREQUENCY	24Hz
COMP.RUN TIME	54 MIN
COMP.TOTAL RUN TIME	1000Hrs
EXPANSION VALVE	200P
⏪ ADDRESS	6/9 ⏩



OPERATION PARAMETER	#01
FAN SPEED	600R/MIN
IDU TARGET FREQUENCY	46Hz
FREQUENCY LIMITED TYPE	5
SUPPLY VOLTAGE	230V
DC GENERATRIX VOLTAGE	420V
DC GENERATRIX CURRENT	18A
ADDRESS	7/9

OPERATION PARAMETER	#01
TW_O PLATE W-OUTLET TEMP.	35°C
TW_I PLATE W-INLET TEMP.	30°C
T2 PLATE F-OUT TEMP.	35°C
T2B PLATE F-IN TEMP.	35°C
Th COMP. SUCTION TEMP.	5°C
Th COMP. DISCHARGE TEMP.	75°C
ADDRESS	8/9

OPERATION PARAMETER	#01
T3 OUTDOOR EXCHANGE TEMP.	5°C
T4 OUTDOOR AIR TEMP.	5°C
TF MODULE TEMP.	55°C
P1 COMP. PRESSURE	2300kPa
ODU SOFTWARE	01-09-2018V01
HMI SOFTWARE	01-09-2018V01
ADDRESS	9/9

### NOTE

The power consumption parameter is preparatory. some parameter is not be activated in the system, the parameter will show "—"

The heat pump capacity is for reference only, not used to judge the ability of the unit. The accuracy of sensor is  $\pm 1^\circ\text{C}$ . The flow rates parameters are calculated according to the pump running parameters, the deviation is different at different flow rates, the maximum of deviation is 25%.

## 13.4 Error codes

When a safety device is activated, an error code will be displayed on the user interface.

A list of all errors and corrective actions can be found in the table below.

Reset the safety by turning the unit OFF and back ON.

In case this procedure for resetting the safety is not successful, contact your local dealer.

ERROR CODE	MALFUNCTION OR PROTECTION	FAILURE CAUSE AND CORRECTIVE ACTION
<i>E0</i>	Water flow fault (E8 displayed 3 times)	<ol style="list-style-type: none"> <li>The wire circuit is short connected or open. Reconnect the wire correctly.</li> <li>Water flow rate is too low.</li> <li>Water flow switch is failed, switch is open or close continuously, change the water flow switch.</li> </ol>
<i>E1</i>	Phase loss or neutral wire and live wire are connected reversely	<ol style="list-style-type: none"> <li>Check the power supply cables should be connected stable, to avoid phase loss.</li> <li>Check the power supply cables sequence, change any two cables sequence of the three power supply cables.</li> </ol>
<i>E2</i>	Communication fault between controller and main control board of hydraulic module	<ol style="list-style-type: none"> <li>The wire doesn't connect between wired controller and unit, connect the wire.</li> <li>Communication wire sequence is not right. Reconnect the wire in the right sequence.</li> <li>Whether there is a high magnetic field or high power interfere, such as lifts, large power transformers, etc..</li> <li>To add a barrier to protect the unit or to move the unit to the other place.</li> </ol>
<i>E3</i>	Final outlet water temp. sensor (T1) fault.	<ol style="list-style-type: none"> <li>Check the resistance of the sensor</li> <li>The T1 sensor connector is loosen. Reconnect it.</li> <li>The T1 sensor connector is wet or there is water in, remove the water, make the connector dry. Add waterproof adhesive.</li> <li>The T1 sensor failure, change a new sensor.</li> </ol>
<i>E4</i>	Water tank temp. sensor (T5) fault.	<ol style="list-style-type: none"> <li>Check the resistance of the sensor</li> <li>The T5 sensor connector is loosen. Reconnect it.</li> <li>The T5 sensor connector is wet or there is water in. remove the water, make the connector dry. Add waterproof adhesive</li> <li>The T5 sensor failure, change a new sensor</li> </ol>

ERROR CODE	MALFUNCTION OR PROTECTION	FAILURE CAUSE AND CORRECTIVE ACTION
<i>E5</i>	The condenser outlet refrigerant temperature sensor (T3) fault.	<ol style="list-style-type: none"> <li>1. Check the resistance of the sensor</li> <li>2. The T3 sensor connector is loosen. Reconnect it.</li> <li>3.The T3 sensor connector is wet or there is water in. remove the water, make the connector dry. Add waterproof adhesive</li> <li>4. The T3 sensor failure, change a new sensor.</li> </ol>
<i>E6</i>	The ambient temperature sensor (T4) fault.	<ol style="list-style-type: none"> <li>1. Check the resistance of the sensor</li> <li>2. The T4 sensor connector is loosen. Reconnect it.</li> <li>3.The T4 sensor connector is wet or there is water in. remove the water, make the connector dry. Add waterproof adhesive</li> <li>4. The T4 sensor failure, change a new sensor.</li> </ol>
<i>E7</i>	The balance tank up temp. sensor (Tbt1) fault.	<ol style="list-style-type: none"> <li>1.Check the resistance of the sensor.</li> <li>2.The Tbt1 sensor connector is loosen,reconnect it.</li> <li>3.The Tbt1 sensor connector is wet or there is water in,remove the water ,make the connector dry.Add waterproof adhesive.</li> <li>4.The Tbt1 sensor failure,change a new sensor.</li> </ol>
<i>E8</i>	Water flow fault.	<p>Check that all shut off valves of the water circuit are completely open.</p> <ol style="list-style-type: none"> <li>1. Check if the water filter needs cleaning.</li> <li>2. Refer to "9.4 Charging water"</li> <li>3. Make sure there is no air in the system(purge air).</li> <li>4. Check on the manometer that there is sufficient water pressure. The water pressure must be &gt;1 bar.</li> <li>5. Check that the pump speed setting is on the highest speed.</li> <li>6. Make sure that the expansion vessel is not broken.</li> <li>7. Check that the resistance in the water circuit is not too high for the pump (refer to "Setting the pump speed" ).</li> <li>8. If this error occurs at defrost operation (during space heating or domestic water heating), make sure that the backup heater power supply is wired correctly and that fuses are not blown.</li> <li>9. Check that the pump fuse and PCB fuse are not blown.</li> </ol>
<i>E9</i>	Compressor suction temp. sensor (Th) fault.	<ol style="list-style-type: none"> <li>1.Check the resistance of the sensor.</li> <li>2. The Th sensor connector is loosen. Reconnect it.</li> <li>3.The Th sensor connector is wet or there is water in. remove the water, make the connector dry. Add waterproof adhesive</li> <li>4. The Th sensor failure, change a new sensor.</li> </ol>
<i>ER</i>	Compressor discharge temp. sensor (Tp) fault.	<ol style="list-style-type: none"> <li>1.Check the resistance of the sensor.</li> <li>2. The Tp sensor connector is loosen. Reconnect it.</li> <li>3.The Tp sensor connector is wet or there is water in. remove the water, make the connector dry. Add waterproof adhesive</li> <li>4. The Tp sensor failure, change a new sensor.</li> </ol>
<i>Eb</i>	Solar panel temp.sensor (Tsolar) fault.	<ol style="list-style-type: none"> <li>1.Check the resistance of the sensor.</li> <li>2.The Tsolar sensor connector is loosen,reconnect it.</li> <li>3.The Tsolar sensor connector is wet or there is water in,remove the water ,make the connector dry.Add waterproof adhesive.</li> <li>4.The Tsolar sensor failure,change a new sensor.</li> </ol>

ERROR CODE	MALFUNCTION OR PROTECTION	FAILURE CAUSE AND CORRECTIVE ACTION
<i>EE</i>	The balance tank low temp.sensor(Tbt2) fault	<ol style="list-style-type: none"> <li>1.Check the resistance of the sensor.</li> <li>2.The Tbt2 sensor connector is loosen,reconnect it.</li> <li>3.The Tbt2 sensor connector is wet or there is water in,remove the water ,make the connector dry,Add waterproof adhesive.</li> <li>4.The Tbt2 sensor failure,change a new sensor.</li> </ol>
<i>Ed</i>	The plate exchanger water inlet temp. sensor (Tw_in) fault.	<ol style="list-style-type: none"> <li>1.Check the resistance of the sensor.</li> <li>2. The Tw_in sensor connector is loosen. Reconnect it.</li> <li>3.The Tw_in sensor connector is wet or there is water in, remove the water, make the connector dry. Add waterproof adhesive</li> <li>4. The Tw_in sensor failure, change a new sensor.</li> </ol>
<i>EE</i>	The main control board of hydraulic module EEPROM fault.	<ol style="list-style-type: none"> <li>1. The EEPROM parameter is error, rewrite the EEPROM data.</li> <li>2. EEPROM chip part is broken, change a new EEPROM chip part.</li> <li>3. main control board of hydraulic module is broken, change a new PCB.</li> </ol>
<i>bH</i>	PED PCB fault	<ol style="list-style-type: none"> <li>1. After 5 minutes of power-off interval, power on again and observe whether it can be recovered;</li> <li>2. If it can't be restored, replace PED safety plate, power on again, and observe whether it can be restored;</li> <li>3. If it can not be recovered, the IPM module board should be replaced.</li> </ol>
<i>E7</i>	High temp. protection of inverter module	<ol style="list-style-type: none"> <li>1. Power supply voltage of the unit is low, increase the power voltage to the required range.</li> <li>2. The space between the units is too narrow for heat exchange. Increase the space between the units.</li> <li>3. Heat exchanger is dirty or something is block on the surface. Clean the heat exchanger or remove the obstruction.</li> <li>4. Fan is not running. Fan motor or fan is broken, Change a new fan or fan motor.</li> <li>5. Water flow rate is low, there is air in system, or pump head is not enough. Release the air and reselect the pump.</li> <li>6. Water outlet temp.sensor is loosen or broken, reconnect it or change a new one.</li> </ol>
<i>F1</i>	DC bus low voltage protection	<ol style="list-style-type: none"> <li>1. Check the power supply.</li> <li>2. If the power supply is OK,and check if LED light is OK, check the voltage PN, if it is 380V, the problem usually comes from the main board. And if the light is OFF, disconnect the power, check the IGBT, check those dioxides, if the voltage is not correct, the inverter board is damaged, change it.</li> <li>3. And if those IGBT are OK, which means the inverter board is OK, power form rectifier bridge is not correct, check the bridge. (Same method as IGBT, disconnect the power, check those dioxides are damaged or not).</li> <li>4. Usually if F1 exist when compressor start, the possible reason is main board. If F1 exist when fan start, it may be because of inverter board.</li> </ol>

ERROR CODE	MALFUNCTION OR PROTECTION	FAILURE CAUSE AND CORRECTIVE ACTION
<i>H0</i>	Communication fault between main control board of hydraulic module and main control board PCB B.	<ol style="list-style-type: none"> <li>1.wire doesn't connect between main control board PCB B and main control board of indoor unit. connect the wire.</li> <li>2. Whether there is a high magnetic field or high power interfere, such as lifts, large power transformers, etc.. To add a barrier to protect the unit or to move the unit to the other place.</li> </ol>
<i>H1</i>	Communication fault between inverter module PCB A and main control board PCB B.	<ol style="list-style-type: none"> <li>1. Whether there is power connected to the PCB and driven board. Check the inverter module PCB indicator light is on or off. If Light is off, reconnect the power supply wire.</li> <li>2.if light is on, check the wire connection between inverter module PCB and main control board PCB, if the wire loosen or broken, reconnect the wire or change a new wire.</li> <li>3. Replace a new main PCB and driven board in turn.</li> </ol>
<i>H2</i>	The plate exchanger refrigerant outlet (liquid pipe) temp. sensor (T2) fault.	<ol style="list-style-type: none"> <li>1.Check the resistance of the sensor</li> <li>2.The T2 sensor connector is loosen. Re connect it.</li> <li>3.The T2 sensor connector is wet or there is water in. remove the water, make the connector dry. Add waterproof adhesive</li> <li>4. The T2 sensor failure, change a new sensor.</li> </ol>
<i>H3</i>	The plate exchanger refrigerant outlet (gas pipe) temp. sensor (T2B) fault.	<ol style="list-style-type: none"> <li>1.Check the resistance of the sensor</li> <li>2. The T2B sensor connector is loosen. Reconnect it.</li> <li>3.The T2B sensor connector is wet or there is water in. remove the water, make the connector dry. Add waterproof adhesive</li> <li>4. The T2B sensor failure, change a new sensor.</li> </ol>
<i>H4</i>	Three times P6 protection	Same to P6
<i>H5</i>	Room temp.sensor (Ta) fault	<ol style="list-style-type: none"> <li>1.Check the resistance of the sensor</li> <li>2. The Ta sensor is in the interface;</li> <li>3. The Ta sensor failure, change a new sensor or change a new interface, or reset the Ta, connect a new Ta from the indoor unit PCB</li> </ol>
<i>H6</i>	DC fan motor fault.	<ol style="list-style-type: none"> <li>1. Strong wind or typhoon below toward to the fan, to make the fan running in the opposite direction. Change the unit direction or make shelter to avoid typhoon below to the fan.</li> <li>2.fan motor is broken, change a new fan motor.</li> </ol>
<i>H7</i>	Main circuit voltage protection fault.	<ol style="list-style-type: none"> <li>1. Whether the power supply input is in the available range.</li> <li>2. Power off and power on for several times rapidly in short time. Remain the unit power off for more than 3 minutes than power on.</li> <li>4. the circuit defect part of Main control board is defective. Replace a new Main PCB.</li> </ol>
<i>H8</i>	Pressure sensor fault.	<ol style="list-style-type: none"> <li>1. Pressure sensor connector is loosen, reconnect it.</li> <li>2. Pressure sensor failure. change a new sensor.</li> </ol>

ERROR CODE	MALFUNCTION OR PROTECTION	FAILURE CAUSE AND CORRECTIVE ACTION
<i>H9</i>	Zone 2 water flow temp. sensor (Tw2) fault.	<ol style="list-style-type: none"> <li>1. Check the resistance of the sensor.</li> <li>2. The Tw2 sensor connector is loosen. Reconnect it.</li> <li>3. The Tw2 sensor connector is wet or there is water in. remove the water, make the connector dry. Add waterproof adhesive</li> <li>4. The Tw2 sensor failure, change a new sensor.</li> </ol>
<i>HA</i>	The plate heat exchanger water outlet temperature sensor (Tw_out) fault.	<ol style="list-style-type: none"> <li>1. Check the resistance of the sensor.</li> <li>2. The TW_out sensor connector is loosen. Reconnect it.</li> <li>3. The TW_out sensor connector is wet or there is water in. remove the water, make the connector dry. Add waterproof adhesive</li> <li>4. The TW_out sensor failure, change a new sensor.</li> </ol>
<i>Hb</i>	Three times "PP" protection and Tw_out < 7°C	The same to "PP".
<i>Hd</i>	Communication fault between master unit and slave unit (in parallel)	<ol style="list-style-type: none"> <li>1. Address code missing or address code setting duplicate, reset address code;</li> <li>2. The connected wire is wrong, reconnect the wire;</li> <li>3. Check whether the main board fuse is damaged;</li> <li>4. Add a network matching wire between the ports H1 and H2 at the terminal of the communication system;</li> <li>5. Put the SW9 to "on" of the master unit</li> </ol>
<i>HE</i>	Communication fault between main control board of hydraulic module and Ta / room thermostat transfer PCB.	<ol style="list-style-type: none"> <li>1. temperature collecting plate is set effectively, but it is not connected with temperature collecting plate.</li> <li>2. temperature collecting plate connection wire is not connected, check the connection line and joint</li> <li>3. Temperature plate damaged, replace it</li> </ol>
<i>HF</i>	Inverter module board EE PROM fault	<ol style="list-style-type: none"> <li>1. The EEPROM parameter is error, rewrite the EEPROM data.</li> <li>2. EEPROM chip part is broken, change a new EEPROM chip part.</li> <li>3. Main PCB is broken, change a new PCB.</li> </ol>
<i>HH</i>	H6 displayed 10 times in 120 minutes.	Refer to H6
<i>HP</i>	Low pressure protection (Pe < 0.6) occurred 3 times in 1 hour in cooling mode	Refer to P0
<i>P0</i>	Low pressure protection	<ol style="list-style-type: none"> <li>1. System is lack of refrigerant volume. Charge the refrigerant in right volume.</li> <li>2. When at heating mode or heat water mode, Heat exchanger is dirty or something is block on the surface. Clean the heat exchanger or remove the obstruction.</li> <li>3. The water flow is low in cooling mode.</li> <li>4. Electrical expansion valve locked or winding connector is loosen. Tap-tap the valve body and plug in/ plug off the connector for several times to make sure the valve is working correctly. And install the winding in the right location.</li> </ol>

ERROR CODE	MALFUNCTION OR PROTECTION	FAILURE CAUSE AND CORRECTIVE ACTION
<i>P1</i>	High pressure protection	Heating mode, DHW mode: 1. The water flow is low; water temp is high, whether there is air in the water system. Release the air. 2. Water pressure is lower than 0.1Mpa, charge the water to let the pressure in the range of 0,15~0.2Mpa. 3. Over charge the refrigerant volume. Recharge the refrigerant in right volume. 4. Electrical expansion valve locked or winding connector is loosen. Tap-tap the valve body and plug in/ plug off the connector for several times to make sure the valve is working correctly. And install the winding in the right location DHW mode: Water tank heat exchanger is smaller than the required 1.7m2.(10-16kW unit)or 1.4m2(5-9kW unit) Cooling mode: 1.Heat exchanger cover is not removed. Remove it. 2. Heat exchanger is dirty or something is block on the surface. Clean the heat exchanger or remove the obstruction.
<i>P3</i>	Compressor overcurrent protection.	1.The same reason to P1. 2. Power supply voltage of the unit is low, increase the power voltage to the required range.
<i>P4</i>	Compressor discharge temp. too high protection	1.The same reason to P1. 2. System is lack of refrigerant volume. Charge the refrigerant in right volume. 3.TW_out temp sensor is loosen Reconnect it.. 4. T1 temp sensor is loosen. Reconnect it. 5. T5 temp sensor is loosen. Reconnect it.
<i>P5</i>	High Temperature difference protection between water inlet and water outlet of the plate heat exchanger.	1. Check that all shut off valves of the water circuit are completely open. 2. Check if the water filter needs cleaning. 3. Refer to "9.4 Charging water" 4. Make sure there is no air in the system (purge air). 5. Check on the manometer that there is sufficient water pressure. The water pressure must be >1 bar(water is cold). 6. Check that the pump speed setting is on the highest speed. 7. Make sure that the expansion vessel is not broken. 8. Check that the resistance in the water circuit is not too high for the pump., (refer to "10.6 Setting the pump speed" ).

ERROR CODE	MALFUNCTION OR PROTECTION	FAILURE CAUSE AND CORRECTIVE ACTION
<i>Pb</i>	Inverter module protection	<ol style="list-style-type: none"> <li>1. Power supply voltage of the unit is low, increase the power voltage to the required range.</li> <li>2. The space between the units is too narrow for heat exchange. Increase the space between the units.</li> <li>3. Heat exchanger is dirty or something is block on the surface. Clean the heat exchanger or remove the obstruction.</li> <li>4. Fan is not running. Fan motor or fan is broken, Change a new fan or fan motor.</li> <li>5. Over charge the refrigerant volume. Recharge the refrigerant in right volume.</li> <li>6. Water flow rate is low, there is air in system, or pump head is not enough. Release the air and reselect the pump.</li> <li>7. Water outlet temp sensor is loosen or broken, reconnect it or change a new one.</li> <li>8. Water tank heat exchanger is smaller than the required 1.7m2,(1016kW unit)or 1.4m2(5-9kW unit).</li> <li>9.Module wires or screws are loosen. Reconnect wires and screws. The Thermal Conductive Adhesive is dry or drop.Add some thermal conductive adhesive.</li> <li>10.The wire connection is loosen or drop. Reconnect the wire.</li> <li>11. Drive board is defective, replace a new one.</li> <li>12. If already confirm the control system has no problem, then compressor is defective, replace a new compressor.</li> </ol>
<i>Pb</i>	Anti-freeze mode protection	Unit will return to the normal operation automatically.
<i>Pd</i>	High temperature protection of refrigerant outlet temp. of condenser.	<ol style="list-style-type: none"> <li>1. Heat exchanger cover is not removed, Remove it.</li> <li>2. Heat exchanger is dirty or something is block on the surface. Clean the heat exchanger or remove the obstruction.</li> <li>3. There is no enough space around the unit for heat exchanging.</li> <li>4. fan motor is broken, replace a new one.</li> </ol>
<i>PP</i>	Water inlet temperature is higher than water outlet in heating mode	<ol style="list-style-type: none"> <li>1.Check the resistance of the sensor.</li> <li>2.The water inlet/outlet sensor wire connector is loosen, Reconnect it.</li> <li>3.The water inlet/outlet (TW_in /TW_out) sensor is broken, Change a new sensor.</li> <li>4. Four-way valve is blocked. Restart the unit again to let the valve change the direction.</li> <li>5.Four-way valve is broken, change a new valve.</li> </ol>

ERROR CODE	MALFUNCTION OR PROTECTION	FAILURE CAUSE AND CORRECTIVE ACTION
<i>L0</i>	DC compressor inverter module fault	<ol style="list-style-type: none"> <li>1. Check the Heat pump system pressure;</li> <li>2. Check the phase resistance of compressor;</li> <li>3. Check the U、V、W power line connection sequence between the inverter board and the compressor;</li> <li>4. Check the L1、L2、L3 power line connection between the inverter board and the Filter board;</li> <li>5. Check the inverter board.</li> </ol>
<i>L1</i>	DC bus low voltage protection (from inverter module mostly when compressor running)	
<i>L2</i>	DC bus high voltage protection from DC driver	
<i>L4</i>	MCE fault	
<i>L5</i>	Zero speed protection	
<i>L7</i>	Phase sequence fault	
<i>L8</i>	Compressor frequency variation greater than 15Hz within 1 second protection	
<i>L9</i>	Actual compressor frequency differs from target frequency by more than 15Hz protection	



## 14 TECHNICAL SPECIFICATIONS

Unit	18kW	22kW	26kW	30kW
Power supply	380-415V 3N~ 50Hz			
Rated input	10.6kW	12.5kW	13.8kW	14.5kW
Rated Current	16.8A	19.6A	21.6A	22.8A
Normal capacity	Refer to the technical data			
Dimensions (W×H×D)[mm]	1129x1558x528			
Packing (W×H×D)[mm]	1220x1735x565			
Heat exchanger	Plate heat exchanger			
Electric heater	/			
Internal water volume	3.5L			
Safety valve	0.3MPa			
Filter mesh	60			
Min. water flow (flow switch)	27L/min			
<b>Pump</b>				
Type	Fixd speed pump			
Max. head	12m			
Power input	262W			
<b>Expansion vessel</b>				
Volume	8L			
Max. operating pressure	1.0MPa			
Pre-charge pressure	0.1MPa			
<b>Weight</b>				
Net weight	177kg			
Gross weight	206kg			
<b>Connections</b>				
Water inlet/outlet	5/4 BSP			
<b>Operation range - water side</b>				
heating model	+5 ~ +60°C			
cooling model	+5 ~ +25°C			
<b>Operation range - air side</b>				
heating model	-25 ~ +35°C			
cooling mode	-5 ~ +46°C			
Domestic hot water	-25 ~ +43°C			

## 15 INFORMATION SERVICING

### 1) Checks to the area

Prior to beginning work on systems containing flammable refrigerants, safety checks are necessary to ensure that the risk of ignition is minimised. For repair to the refrigerating system, the following precautions shall be complied with prior to conducting work on the system.

### 2) Work procedure

Works shall be undertaken under a controlled procedure so as to minimise the risk of a flammable gas or vapour being present while the work is being performed.

### 3) General work area

All maintenance staff and others working in the local area shall be instructed on the nature of work being carried out. Work in confined spaces shall be avoided. The area around the work space shall be sectioned off. Ensure that the conditions within the area have been made safe by control of flammable material.

### 4) Checking for presence of refrigerant

The area shall be checked with an appropriate refrigerant detector prior to and during work, to ensure the technician is aware of potentially flammable atmospheres. Ensure that the leak detection equipment being used is suitable for use with flammable refrigerants, i.e. no sparking, adequately sealed or intrinsically safe.

### 5) Presence of fire extinguisher

If any hot work is to be conducted on the refrigeration equipment or any associated parts, appropriate fire extinguishing equipment shall be available to hand. Have a dry power or CO<sup>2</sup> fire extinguisher adjacent to the charging area.

### 6) No ignition sources

No person carrying out work in relation to a refrigeration system which involves exposing any pipe work that contains or has contained flammable refrigerant shall use any sources of ignition in such a manner that it may lead to the risk of fire or explosion. All possible ignition sources, including cigarette smoking, should be kept sufficiently far away from the site of installation, repairing, removing and disposal, during which flammable refrigerant can possibly be released to the surrounding space. Prior to work taking place, the area around the equipment is to be surveyed to make sure that there are no flammable hazards or ignition risks. NO SMOKING signs shall be displayed.

### 7) Ventilated area

Ensure that the area is in the open or that it is adequately ventilated before breaking into the system or conducting any hot work. A degree of ventilation shall continue during the period that the work is carried out. The ventilation should safely disperse any released refrigerant and preferably expel it externally into the atmosphere.

### 8) Checks to the refrigeration equipment

Where electrical components are being changed, they shall be fit for the purpose and to the correct specification. At all times the manufacturer's maintenance and service guidelines shall be followed. If in doubt consult the manufacturer's technical department for assistance. The following checks shall be applied to installations using flammable refrigerants:

- The charge size is in accordance with the room size within which the refrigerant containing parts are installed;
- The ventilation machinery and outlets are operating adequately and are not obstructed;
- If an indirect refrigerating circuit is being used, the secondary circuits shall be checked for the presence of refrigerant; marking to the equipment continues to be visible and legible.
- Marking and signs that are illegible shall be corrected;
- Refrigeration pipe or components are installed in a position where they are unlikely to be exposed to any substance which may corrode refrigerant containing components, unless the components are constructed of materials which are inherently resistant to being corroded or are suitably protected against being so corroded.

### 9) Checks to electrical devices

Repair and maintenance to electrical components shall include initial safety checks and component inspection procedures. If a fault exists that could compromise safety, then no electrical supply shall be connected to the circuit until it is satisfactorily dealt with. If the fault cannot be corrected immediately but it is necessary to continue operation, and adequate temporary solution shall be used. This shall be reported to the owner of the equipment so all parties are advised.

Initial safety checks shall include:

- That capacitors are discharged: this shall be done in a safe manner to avoid possibility of sparking;
- That there are no live electrical components and wiring are exposed while charging, recovering or purging the system;
- That there is continuity of earth bonding.

### 10) Repairs to sealed components

a) During repairs to sealed components, all electrical supplies shall be disconnected from the equipment being worked upon prior to any removal of sealed covers, etc. If it is absolutely necessary to have an electrical supply to equipment during servicing, then a permanently operating form of leak detection shall be located at the most critical point to warn of a potentially hazardous situation.

b) Particular attention shall be paid to the following to ensure that by working on electrical components, the casing is not altered in such a way that the level of protection is affected. This shall include damage to cables, excessive number of connections, terminals not made to original specification, damage to seals, incorrect fitting of glands, etc.

- Ensure that apparatus is mounted securely.
- Ensure that seals or sealing materials have not degraded such that they no longer serve the purpose of preventing the ingress of flammable atmospheres. Replacement parts shall be in accordance with the manufacturer's specifications.

#### NOTE

The use of silicon sealant may inhibit the effectiveness of some types of leak detection equipment. Intrinsically safe components do not have to be isolated prior to working on them.

#### 11) Repair to intrinsically safe components

Do not apply any permanent inductive or capacitance loads to the circuit without ensuring that this will not exceed the permissible voltage and current permitted for the equipment in use. Intrinsically safe components are the only types that can be worked on while live in the presence of a flammable atmosphere. The test apparatus shall be at the correct rating. Replace components only with parts specified by the manufacturer. Other parts may result in the ignition of refrigerant in the atmosphere from a leak.

#### 12) Cabling

Check that cabling will not be subject to wear, corrosion, excessive pressure, vibration, sharp edges or any other adverse environmental effects. The check shall also take into account the effects of aging or continual vibration from sources such as compressors or fans.

#### 13) Detection of flammable refrigerants

Under no circumstances shall potential sources of ignition be used in the searching for or detection of refrigerant leaks. A halide torch (or any other detector using a naked flame) shall not be used.

#### 14) Leak detection methods

The following leak detection methods are deemed acceptable for systems containing flammable refrigerants. Electronic leak detectors shall be used to detect flammable refrigerants, but the sensitivity may not be adequate, or may need re-calibration. (- Detection equipment shall be calibrated in a refrigerant-free area.) Ensure that the detector is not a potential source of ignition and is suitable for the refrigerant. Leak detection equipment shall be set at a percentage of the LFL of the refrigerant and shall be calibrated to the refrigerant employed and the appropriate percentage of gas (25% maximum) is confirmed. Leak detection fluids are suitable for use with most refrigerants but the use of detergents containing chlorine shall be avoided as the chlorine may react with the refrigerant and corrode the copper pipe-work. If a leak is suspected, all naked flames shall be removed or extinguished. If a leakage of refrigerant is found which requires brazing, all of the refrigerant shall be recovered from the system, or isolated (by means of shut off valves) in a part of the system remote from the leak. Oxygen free nitrogen (OFN) shall then be purged through the system both before and during the brazing process.

#### 15) Removal and evacuation

When breaking into the refrigerant circuit to make repairs or for any other purpose conventional procedures shall be used. However, it is important that best practice is followed since flammability is a consideration. The following procedure shall be adhered to:

- Remove refrigerant;
- Purge the circuit with inert gas;
- Evacuate;
- Purge again with inert gas;
- Open the circuit by cutting or brazing.

The refrigerant charge shall be recovered into the correct recovery cylinders. The system shall be flushed with OFN to render the unit safe. This process may need to be repeated several times.

Compressed air or oxygen shall not be used for this task.

Flushing shall be achieved by breaking the vacuum in the system with OFN and continuing to fill until the working pressure is achieved, then venting to atmosphere, and finally pulling down to a vacuum. This process shall be repeated until no refrigerant is within the system.

When the final OFN charge is used, the system shall be vented down to atmospheric pressure to enable work to take place. This operation is absolutely vital if brazing operations on the pipe-work are to take place.

Ensure that the outlet for the vacuum pump is not closed to any ignition sources and there is ventilation available.

#### 16) Charging procedures

In addition to conventional charging procedures, the following requirements shall be followed:

- Ensure that contamination of different refrigerants does not occur when using charging equipment. Hoses or lines shall be as short as possible to minimize the amount of refrigerant contained in them.
- Cylinders shall be kept upright.
- Ensure that the refrigeration system is earthed prior to charging the system with refrigerant.
- Label the system when charging is complete (if not already).

- Extreme care shall be taken not to overfill the refrigeration system.
- Prior to recharging the system it shall be pressure tested with OFN. The system shall be leak tested on completion of charging but prior to commissioning. A follow up leak test shall be carried out prior to leaving the site.

#### 17) Decommissioning

Before carrying out this procedure, it is essential that the technician is completely familiar with the equipment and all its detail. It is recommended good practice that all refrigerants are recovered safely. Prior to the task being carried out, an oil and refrigerant sample shall be taken.

In case analysis is required prior to re-use of reclaimed refrigerant. It is essential that electrical power is available before the task is commenced.

a) Become familiar with the equipment and its operation.

b) Isolate system electrically

c) Before attempting the procedure ensure that:

- Mechanical handling equipment is available, if required, for handling refrigerant cylinders;
- All personal protective equipment is available and being used correctly;
- The recovery process is supervised at all times by a competent person;
- Recovery equipment and cylinders conform to the appropriate standards.

d) Pump down refrigerant system, if possible.

e) If a vacuum is not possible, make a manifold so that refrigerant can be removed from various parts of the system.

f) Make sure that cylinder is situated on the scales before recovery takes place.

g) Start the recovery machine and operate in accordance with manufacturer's instructions.

h) Do not overfill cylinders. (No more than 80% volume liquid charge).

i) Do not exceed the maximum working pressure of the cylinder, even temporarily.

j) When the cylinders have been filled correctly and the process completed, make sure that the cylinders and the equipment are removed from site promptly and all isolation valves on the equipment are closed off.

k) Recovered refrigerant shall not be charged into another refrigeration system unless it has been cleaned and checked.

#### 18) Labelling

Equipment shall be labelled stating that it has been de-commissioned and emptied of refrigerant. The label shall be dated and signed. Ensure that there are labels on the equipment stating the equipment contains flammable refrigerant.

#### 19) Recovery

When removing refrigerant from a system, either for service or decommissioning, it is recommended good practice that all refrigerants are removed safely.

When transferring refrigerant into cylinders, ensure that only appropriate refrigerant recovery cylinders are employed. Ensure that the correct numbers of cylinders for holding the total system charge are available. All cylinders to be used are designated for the recovered refrigerant and labelled for that refrigerant (i.e. special cylinders for the recovery of refrigerant). Cylinders shall be complete with pressure relief valve and associated shut-off valves in good working order.

Empty recovery cylinders are evacuated and, if possible, cooled before recovery occurs.

The recovery equipment shall be in good working order with a set of instructions concerning the equipment that is at hand and shall be suitable for the recovery of flammable refrigerants. In addition, a set of calibrated weighing scales shall be available and in good working order.

Hoses shall be complete with leak-free disconnect couplings and in good condition. Before using the recovery machine, check that it is in satisfactory working order, has been properly maintained and that any associated electrical components are sealed to prevent ignition in the event of a refrigerant release. Consult manufacturer if in doubt.

The recovered refrigerant shall be returned to the refrigerant supplier in the correct recovery cylinder, and the relevant Waste Transfer Note arranged. Do not mix refrigerants in recovery units and especially not in cylinders.

If compressors or compressor oils are to be removed, ensure that they have been evacuated to an acceptable level to make certain that flammable refrigerant does not remain within the lubricant. The evacuation process shall be carried out prior to returning the compressor to the suppliers. Only electric heating to the compressor body shall be employed to accelerate this process. When oil is drained from a system, it shall be carried out safely.

#### 20) Transportation, marking and storage for units

Transport of equipment containing flammable refrigerants Compliance with the transport regulations

Marking of equipment using signs Compliance with local regulations

Disposal of equipment using flammable refrigerants Compliance with national regulations

Storage of equipment/appliances

The storage of equipment should be in accordance with the manufacturer's instructions.

Storage of packed (unsold) equipment

Storage package protection should be constructed such that mechanical damage to the equipment inside the package will not cause a leak of the refrigerant charge.

The maximum number of pieces of equipment permitted to be stored together will be determined by local regulations.

## ANNEX A: Refrigerant cycle

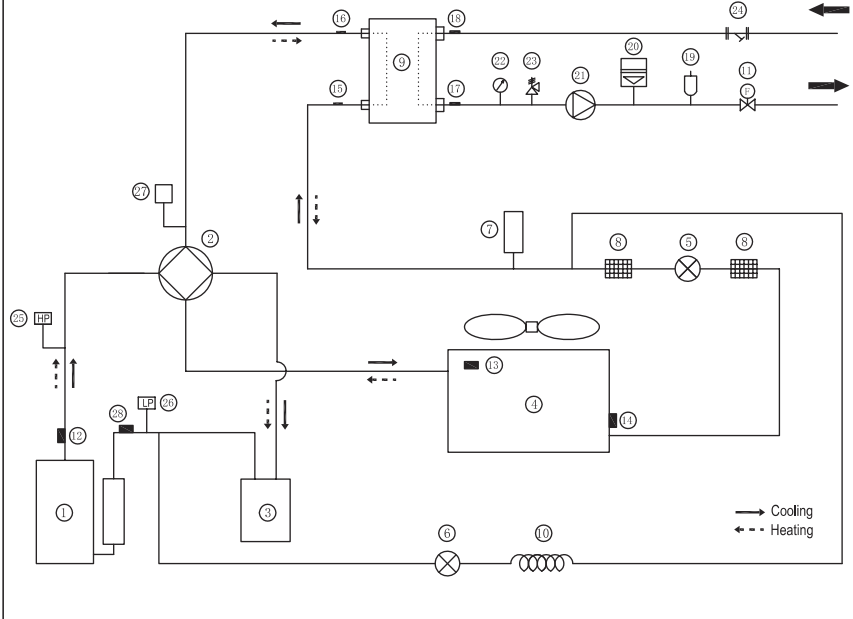

Item	Description	Item	Description
1	Compressor	15	Refrigerant inlet (liquid pipe) temp. sensor
2	4-Way Valve	16	Refrigerant outlet (gas pipe) temp. sensor
3	Gas-liquid separator	17	Water outlet temp. sensor
4	Air side heat exchanger	18	Water Inlet temp. sensor
5	Electronic expansion Valve	19	Air purge valve
6	Single-way electromagnetic valve	20	Expansion vessel
7	Liquid Tank	21	Circulating pump
8	Strainer	22	Manometer
9	Water Side Heat Exchanger (Plate Heat Exchange)	23	Safety valve
10	Capillary	24	Y-shape filter
11	Flow switch	25	High Pressure Switch
12	Discharge temperature sensor	26	Low Pressure Switch
13	Outdoor temperature sensor	27	Pressure valve
14	Evaporation sensor in heating (Condenser sensor in cooling)	28	Suction temperature sensor

## ANNEX B:

### To install the E-heating tape at the drainage outlet (by client)

Connect the wire of heating tape at the drainage outlet to the wire joint XT3.

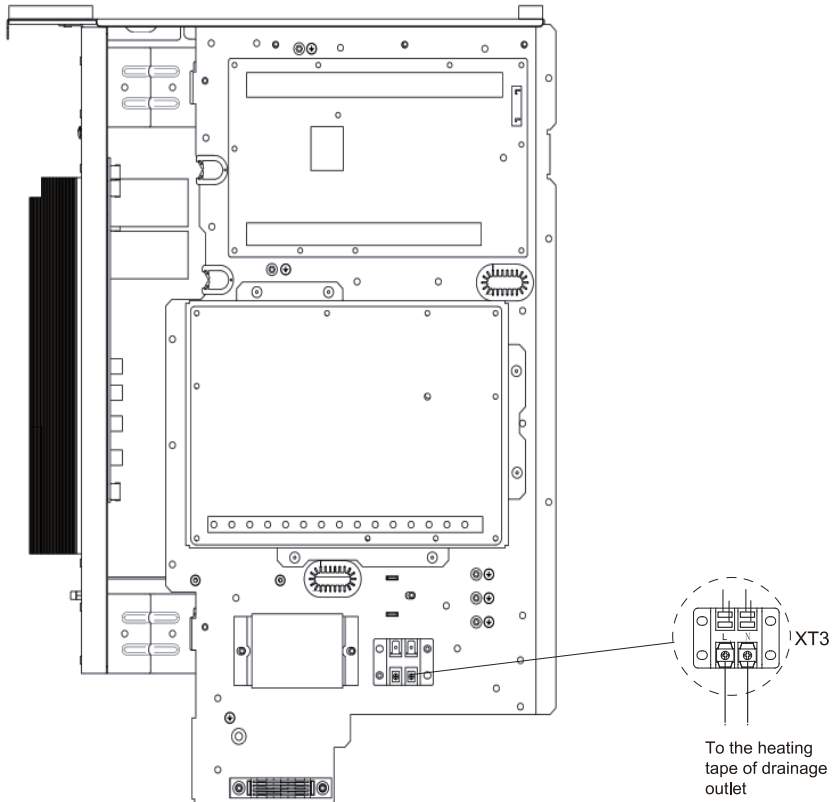

#### NOTE:

The picture is for reference only, please refer to the actual product.

The power of the E-heating tape shall not exceed 40W/200mA, supply voltage 230VAC.



**VIVAX**

[www.VIVAX.com](http://www.VIVAX.com)